

A GUIDANCE MANUAL | 2022

For Policymakers and Regulators for the Environmentally Sound Management of Waste or Used Lead Acid Batteries in Africa



Guidance Manual For Policymakers and Regulators for the Environmentally Sound Management of Waste or Used Lead Acid Batteries in Africa

ISBN No: 978-92-807-4004-2

Job No: DTI/2502/PA

This publication may be reproduced in whole or in part and in any form for educational or non-profit services without special permission from the copyright holder, provided acknowledgement of the source is made. The United Nations Environment Programme would appreciate receiving a copy of any publication that uses this publication as a source.

No use of this publication may be made for resale or any other commercial purpose whatsoever without prior permission in writing from the United Nations Environment Programme. Applications for such permission, with a statement of the purpose and extent of the reproduction, should be addressed to the Director, Communication Division, United Nations Environment Programme, P. O. Box 30552, Nairobi 00100, Kenya.

No use of this publication may be made for resale or any other commercial purpose whatsoever without prior permission in writing from the United Nations Environment Programme. Applications for such permission, with a statement of the purpose and extent of the reproduction, should be addressed to the Director, Communication Division, United Nations Environment Programme, P. O. Box 30552, Nairobi 00100, Kenya.

Suggested citation

United Nations Environment Programme (2022). A Guidance Manual for Policy Makers and Regulators for the Environmentally Sound Management of Waste Lead Acid Batteries in Africa.

Production

United Nations Environment Programme (UNEP)

Disclaimers

The designations employed and the presentation of the material in this publication do not imply the expression of any opinion whatsoever on the part of the Secretariat of the United Nations concerning the legal status of any country, territory or city or area or its authorities, or concerning the delimitation of its frontiers or boundaries. For general guidance on matters relating to the use of maps in publications please go to <http://www.un.org/Depts/Cartographic/english/htmain.htm>

Mention of a commercial company or product in this document does not imply endorsement by the United Nations Environment Programme or the authors. The use of information from this document for publicity or advertising is not permitted. Trademark names and symbols are used in an editorial fashion with no intention on infringement of trademark or copyright laws.

The views expressed in this publication are those of the authors and do not necessarily reflect the views of the United Nations Environment Programme. We regret any errors or omissions that may have been unwittingly made.

© Maps, photos and illustrations as specified

Supported by:



Co-funded by
the European Union

Acknowledgments

The Guidance Manual on the Environmentally Sound Management of Waste Lead Acid Batteries has been developed by UNEP with the support of Pure Earth and funding from the European Commission in response to the UNEA Resolution UNEP/EA.3/Res.9 on Eliminating Exposure to Lead Paint and Promoting Environmentally Sound Management of Waste Lead- Acid Batteries.

The work has been led by Maria Cristina Zucca and Muhammed Omotola from the Pollution and Health Unit, Chemicals and Health Branch of the Economy Division, UNEP, with contributions from other UNEP colleagues namely Kenneth Davis, Noline Lavanchy, Kevin Helps, Bret Ericson, Dina Abdelhakim, Katherine Theotocatos, the Secretariat to the Basel, Rotterdam, and Stockholm Conventions; and Steve Binks and Fareha Lasker of the International Lead Association.

The Guidance Manual was prepared by Pure Earth under the authorship of Brian Wilson, Pure Earth Technical Advisor with the assistance of Pure Earth staff members and Technical Advisors, including Gordon Binkhorst, Barbara Jones, Hassanatou Anna Samake, Judith St. Fort, and Drew McCartor. Thank you to Mara Ranville and Lucy Baker for reviewing and editing the document. Several sections of the present Guidance Manual are based on the Basel Convention Training manual for the preparation of national used lead acid batteries environmentally sound management plans in the context of the implementation of the Basel Convention, (Basel Convention Secretariat 2004).

UNEP promotes environmentally sound practices globally and in its own activities. Our distribution policy aims to reduce UNEP's carbon footprint.

INDEX

<i>Section</i>	<i>Title</i>	<i>Page</i>
i	Figures and Tables	iv
ii	Abbreviations	v
iii	This Guidance Manual	vi
1	Introduction	2
2	Existing International Conventions and Domestic Legislation for Regulating Waste Lead Acid Batteries WLAB	4
2.1	Classification of WLABs under the Basel Convention	4
2.2	Basel Convention Regional and Coordinating Centres for Africa	4
2.3	Control Mechanisms Procedure under the Basel Convention	5
2.4	Basel Convention Ban Amendment	6
2.5	The Bamako Convention	6
2.6	Domestic Legislation	7
3	Assessing and Promoting the Environmentally Sound Management of WLABs at the National and/or Regional Level	9
3.1	Analyze Current WLAB Management	9
3.2	Prioritize and Assign Roles and Responsibilities for Managing Various Aspects of ESM of WLABs	9
3.3	Prepare and Implement a Strategy to Promote the ESM of WLABs	10
3.4	Monitor and Scrutinize the Implementation of Policies and Strategies to Manage WLABs	11
Case Study		
	Ghana: Setting, Monitoring, and Enforcing Environmental and Occupational Health Standards for WLAB Recycling	12
Case Studies		
	Burkina Faso and Tanzania: How a LAB and WLAB Inventory and Trade Analysis Provided Essential Information for the Development of National Strategies for the Management of WLABs	14
4	Environmentally Sound Management of Waste Lead Acid Batteries WLAB in the Licensed Sector	16
4.1	WLAB Collection, Storage, and Transportation	16
4.2	Licensed Sector Recycling Facilities	18
4.2.1	Location	18
4.2.2	Operations	18
4.2.3	Waste Management	20
Case Study		
	Recycling of Used Lead Acid Battery Slag into Fired Clay Bricks in Nigeria: A Waste-to- Wealth Initiative	21
5	Occupational Health and Safety Procedures for Waste Lead Acid Battery Recycling	22
5.1	WLAB Reception	22
5.2	WLAB Breaking and the Effluent Treatment Plant	22
5.3	WLAB Melting, Smelting, and Refining Operations	23
5.4	Housekeeping and Amenity Provisions	24
6	Legislation, Strategies, and Policies for Eliminating the Unsound WLAB Recycling Activities of the Informal Sector	25
6.1	Introduction	25
6.2	Identifying the Barriers to ESM and the Reasons for Informal WLAB Recycling	25

6.3	Removing Barriers and Solutions for Implementing a Formalization Strategy	30
6.4	Removing the Final Barriers to Formalizing the Informal Sector	30
Case Study		
	Eliminating Informal WLAB Recycling and Developing an Environmentally Sound WLAB Recycling Industry in Senegal	28
7	Effective Public Communication, Awareness, and Education	29
Case Study		
	Against All Odds: How Phyllis Omido Changed WLAB Recycling in Kenya through Effective Communication and Compelling Information	31
8	Strategies for the Identification, Investigation, and Remediation of Legacy WLAB Recycling Sites	33
8.1	Sources of Lead and Exposure Pathways from WLAB Sites	33
8.2	Core Principles of Lead-contaminated Site Remediation and Risk Mitigation	34
8.3	Steps to Implement National Remediation Programs, Site Remediation and Risk Mitigation Projects	35
Case Study		
	Lead Poisoning and Intervention in Thiaroye-sur-Mer, Dakar, Senegal	36
References		37
Figures & Tables		
<i>Fig/Tab</i>	<i>Title</i>	<i>page</i>
Fig. 1	The banks of the Volta River, Ghana	6
Fig. 2	LAB life cycle chart for a country with domestic LAB manufacturing and imports	10
Fig. 3	Workshop participants for the ESM of WLABs	12
Fig. 4	WLAB Collection – Health and Safety Risks, Pathways and Mitigation	17
Fig. 5	Stacked WLABs in transit from St. Lucia to Venezuelavia Trinidad	17
Fig. 6	UN 2794 Certified leakproof container for WLABs	17
Fig. 7	WLABs in a covered storage shed in Tanzania	17
Fig. 8	Two typical UN 2794 HAZMAT Class 8 decals commonly seen on vehicles transporting WLABs	18
Fig. 9	Mechanical WLAB breaker and twin furnace operation for metallics and paste (Courtesy of the ILA)	18
Fig. 10	Schematic of a typical filter plant, or baghouse, designed to capture lead dust	19
Fig. 11	Key WLAB recycling processes	22
Fig. 12	WLAB Reception – Risks, Pathways and Mitigation	22
Fig. 13	Ventilated battery saw	22
Fig. 14	WLAB automated hammer mill breaker	23
Fig. 15	WLAB Breaking and ETP – Risks, Pathways and Mitigation	23
Fig. 16	Melting, smelting, and refining – Risks, Pathways and Mitigation	24
Fig. 17	Amenity block with segregated clean and plant services	24
Fig. 18	Closed Loop and EPR for a country without LAB manufacturing	27
Fig. 19	The Seven Effective Communication Principles	29
Tab. 1	Roadblocks to Site Inspections and Possible Solutions to Remove Them	26

For Policymakers and Regulators for the Environmentally Sound Management of Waste or Used Lead Acid Batteries in Africa

Abbreviations

BCCC	Basel Convention Coordinating Centre	N95	US mask/cartridge filter – removes 95% of particulates at 0.3 microns
BCRC	Basel Convention Regional Centre	NEMA	National Environmental Management Agency
BLL	Blood Lead Level	NGO	Non-Governmental Organization
CDC	Centers for Disease Control	OAU	Organisation of African Unity
CJGEA	Centre for Justice, Governance, and Environmental Action	OECD	Organization for Economic Cooperation and Development
EPA	Environmental Protection Agency	Oeko	Oeko Institute
EPR	Extended Producer Responsibility	OK International	Occupational Knowledge International
EPZ	Export Processing Zone	Pb	Lead
ESM	Environmentally Sound Management	PHA	Public Health Agency
ETP	Effluent Treatment Plant	PIC	Prior Informed Consent
EU	European Union	PPE	Personal Protective Equipment
FFP2	Filtering Facepiece – removes 95% of particulates at 0.3 microns	ppm	Parts Per Million
FID	Factories Inspectorate Department	SLAB	Spent Lead Acid Batteries
GDP	Gross Domestic Product	SPLP	Synthetic Precipitation Leaching Procedure
GPS	Global Positioning Satellite	SRI	Sustainable Recycling Industries
GST	Goods and Services Tax	STC	Science, Technology and Consulting, Incorporated
HAZMAT	Hazardous Materials	TCLP	Toxicity Characteristic Leaching Procedure
HSE	Health, Safety, and Environment	TSM	Thiaroye-sur-Mer
ID	Induction Draft	ULAB	Used Lead Acid Battery
ILA	International Lead Association	UN	United Nations
ILPPW	International Lead Poisoning Prevention Week	UNEP	United Nations Environment Programme
ILO	International Labour Organisation	UNICEF	United Nations Children's Fund
ILZSG	International Lead Zinc Study Group	USD	US Dollar
ILMC	International Lead Management Centre	WHO	World Health Organisation
LAB	Lead Acid Battery	WLAB	Waste Lead Acid Battery
LMIC	Lower- and Middle-Income Countries	VAT	Value Added Tax
MRL	Metal Refinery Limited	XRF	X-Ray Fluorescence

Environmentally Sound Management of Waste or Used Lead Acid Batteries in Africa

This Guidance Manual provides an overview of the steps that governments and stakeholders can take to evaluate the present state of waste lead acid battery (WLAB) management and, as warranted, introduce policies and regulations to properly manage WLABs throughout the supply chain in an environmentally sound manner (ESM). Strategies, considerations, and tools to help achieve these goals and objectives in Africa, while focused on UNEP's Seven Pillars for the ESM of WLABs, are addressed throughout this Guidance Manual. This Guidance Manual is intended to provide an introductory framework to understand and achieve the ESM of WLABs in a particular national or regional setting. It is organized in sections targeting the following topics:

- Reviewing and evaluating existing international conventions, domestic legislation and management policies regulating waste lead acid batteries, including monitoring and enforcement (Section 2)
- Assessing and promoting the ESM of WLABs at the national and/or regional level, including performing a supply chain analysis to understand the current flow and disposition of new and used batteries; completing an ESM capacity assessment; identifying and assigning roles and responsibilities for the various aspects of ESM; formulating national ESM strategies, including financial incentives to promote ESM; and ensuring monitoring and enforcement of ESM of WLABs (Section 3)
- Understanding what the ESM of WLABs along the supply chain (e.g., collection, storage, transportation, and recycling) should look like, i.e., "best practices" in WLAB management in the formal sector (Section 4)
- Promoting occupational health and safety procedures and practices pertinent to the various components of WLAB handling and recycling, which should be employed by all actors in both the formal and informal sectors (Section 5)
- Promoting legislation and policies to reduce and ultimately eliminate unsound management of WLABs in the informal sector (Section 6)
- Promoting ESM of WLABs through communications and education of those involved in the LAB industry, the WLAB industry, consumers, and populations at risk in the context of a public health concern (Section 7)
- Identifying and considering policies to investigate and remediate lead-contaminated sites associated with unsound management of WLABs (Section 8)

It's important to note that this Guidance Manual is intended to introduce and familiarize its readers with key elements for consideration in promoting the ESM of WLABs at national and regional levels.

Section 1

The use of lead acid batteries (LABs) in Africa and elsewhere is essential for storage of energy in the automotive and industrial sectors, including in cars, trucks, electric vehicles and bicycles, and off-the-grid power storage associated with the telecommunications and renewable energy sectors. The popularity of LABs is due to their relative simplicity and affordability. However, the lifespan of a typical LAB is limited to a few years, after which these LABs become “waste LABs” (WLABs), also referred to as “used” or “spent” LABs (ULABs or SLABs). A study by Oeko Institute estimated that each year Africa generates more than 1 million metric tonnes of WLABs from vehicles and 170,000 metric tonnes of WLABs from uninterrupted power supplies (Manhart, Amara and Kuepou 2016).

Lead is one of the most recycled materials on Earth, even exceeding recycling rates of glass, paper, and aluminum. Notably, lead can be recycled indefinitely without a loss of quality, making it an ideal material for a circular economy (ILA n.d.). Secondary (recycled) lead accounts for more than 60% of global lead consumption and is at least four times more energy-efficient to produce than primary (mined) lead (ibid.). Recycling rates for WLABs are high throughout the world because WLABs are generally not discarded or disposed of in landfills due to lead’s value as a commodity.

Improper management of WLABs can result in releases of lead, lead compounds, and battery electrolyte, to the environment, resulting in adverse impacts to soil, water and air. Lead is also highly toxic and can have adverse human health impacts, especially for young children. Indeed, according to the

World Health Organization (WHO) (2022), there is no safe level of population lead exposure. The battery electrolyte, which is dilute sulfuric acid and highly corrosive, dissolves concrete and is toxic to aquatic life. In this context, improper WLAB recycling can cause releases of lead that result in dangerous occupational and public exposures and devastating impacts to human health and the environment. Lead is particularly harmful to children, affecting almost every organ in a child’s body, including the heart, lungs, and kidneys. In addition, the plastic case material, if not handled and either disposed of safely or recycled can pose long-term environmental problems.

Perhaps most concerning is the fact that exposure to lead can permanently damage a child’s developing brain, resulting in decreased intelligence, possible behavioral disorders, and lifelong learning problems. A recent report titled *The Toxic Truth: Children’s Exposure to Lead Pollution Undermines a Generation of Future Potential* finds that one in three children globally have elevated levels of lead in their blood, and that unsound WLAB recycling is a significant driver of exposures (Pure Earth and UNICEF 2020).

Recent reports by Oeko Institute, “The Ecologist” in Kenya, and OK International demonstrate that unregulated, informal, environmentally unsound WLAB recycling is prevalent in many African nations (Manhart, Amara and Kuepou 2016; García and Marín 2016; Gottesfield *et al.* 2018). These informal recycling operations (the so-called informal sector) frequently contaminate local environmental media and food, leaving communities at risk of lead exposure until the area is remediated.

The environmentally sound management (ESM) of WLABs is defined in the Basel Convention Technical Guidelines for the Environmentally Sound Management of Waste Lead Acid Batteries as the safe and sustainable handling and recycling of WLABs in a well-regulated, closed-loop supply chain that protects human health and the environment from any adverse effects that may result, i.e., referred to normally as the formal recycling sector (UNEP 2003). WLABs are an ideal candidate for a closed-loop or circular economy because most materials recovered from WLABs can be used to produce new LABs. Promoting the ESM of WLABs across the supply chain (e.g., collection, storage, transportation, smelting, and waste management) requires governmental agencies, industry representatives, and other stakeholders to work together to achieve common goals and objectives, including:

- Regulatory and fiscal environment that is supportive of ESM of WLABs.
- Proper collection, storage, handling, and transportation of WLABs.
- Recycling of WLABs at licensed, environmentally sound WLAB recycling plants with appropriate environmental controls to minimize impacts to human health and the environment.
- Worker health and safety throughout the WLAB supply chain.
- Proper management of all WLAB components and waste products.

The above goals and objectives contribute to the implementation of the Basel Convention, which is the most comprehensive global environmental agreement on hazardous and other wastes. The goals and objectives are also consistent with UNEP's Seven Pillars for the ESM of hazardous wastes, which in the context of WLABs are (Sianipar *et al.* 2013):

1. Minimization of the generation of WLABs by extending the life of LABs
2. Sustainable use of resources during production, consumption, and recycling
3. Recognition that WLABs are a resource for the recovery of lead and other by-products
4. Adoption of an integrated life-cycle approach to LAB production and the recycling of WLABs
5. Environmentally sound recycling of WLABs as close to the source as possible
6. Strict control of the domestic and transboundary movements of WLABs through prior informed consent (PIC)
7. Confirmation of the safe and environmentally sound recycling of WLABs

Section 2

Existing International Conventions and Domestic Legislation for Regulating Waste Lead Acid Batteries

International conventions and domestic legislation provide the framework under which WLABs are managed. Understanding these existing structures and the obligations inferred are important first steps in formulating additional regulations, policies, and programs for the ESM of WLABs.

2.1 Classification of WLABs under the Basel Convention

The Basel Convention is the most comprehensive global treaty designed to protect human health and the environment against the adverse effects of hazardous and non-hazardous wastes (UNEP 1992). The scope of the Convention covers a wide range of hazardous wastes based on their origin and/or composition, as well as their toxic characteristics, and includes waste lead acid batteries, also referred to as used lead acid batteries. The ESM practices and protocols of WLABs are covered in the *Technical Guidelines for the Environmentally Sound Management of Waste Lead Acid Batteries* (UNEP 2003). Non-hazardous wastes covered by the Basel Convention include household wastes, residues from incineration of such wastes, and certain plastic wastes.

The principles, objectives, and provisions of the Basel Convention include and are centered around the following:

- To reduce hazardous waste generation and promote the ESM of hazardous and other wastes (in Annex IV of the Convention, recycling is included and defined as a disposal operation that reduces hazardous waste destined for final disposal).
- To restrict transboundary movements of hazardous wastes and other wastes except where it is perceived to
- be aligned with the principles of ESM in accordance with the proximity principle (Article 4), which states that
- the hazardous waste should be disposed of as close as possible to the place it was generated, consistent with the environmentally sound and efficient management of such wastes.
- Apply a control procedure that is based on notification and the prior informed consent (PIC) of all States concerned in a transboundary movement of hazardous and other wastes.

The first objective outlined above is contained in Article 4 of the Convention and maintained through the PIC control procedure, which should ensure that waste is managed appropriately by agreement and only takes place following notification from the country of export and the prior informed consent between the exporting and importing countries, as well as any countries of transit (Articles 6 and 7 of the Convention).

2.2 Basel Convention Regional and Coordinating Centres for Africa

The Basel Convention also provides for the establishment of Regional and Coordinating Centres for training and technology transfers. The centers' focus is on training and technology transfer with regard to the management of hazardous and other wastes and the minimization of their generation, specifically targeting the needs of the different regions and subregions (Article 14). The Centres support the Parties' efforts to implement the Convention, operating under the authority of the Conference of the Parties including PIC procedure and waste minimization.

The Basel Convention Regional and Coordinating Centres located in the African region are (UNEP n.d. a):

- Basel Convention Regional Centre for Training and Technology Transfer for the Arab States, Egypt (BCRC Egypt), hosted by Cairo University in Giza, Egypt.
- Basel Convention Coordinating Centre for Training and Technology Transfer for the African Region, Nigeria (BCCC Nigeria), hosted by the University of Ibadan in Ibadan, Nigeria.
- Basel Convention Regional Centre for Training and Technology Transfer for French-speaking countries in Africa, Senegal (BCRC Senegal), hosted by the Department of the Environment in Dakar, Senegal.
- Basel Convention Regional Centre for Training and Technology Transfer for the English-speaking African Countries in South Africa (BCRC South Africa), based in Pretoria, South Africa.

2.3 Control Mechanisms Procedure under the Basel Convention

The Basel Convention control mechanism for the transboundary movement of wastes, including WLABs, needs to be followed and enforced to ensure and facilitate the legitimate, environmentally sound import, transit, or export of WLABs. The complete procedure, based on prior informed consent, is described in detail in the Basel Convention Guide to the Control System (UNEP 2015). The procedure is based on notification, consent and the issuance of relevant documents, transboundary movement, and confirmation of disposal, including recycling if that is the disposal option. The notification and movement documents adopted by the Parties for use in the Basel Convention procedure, including instructions on how to complete the documents, can be downloaded from the Basel Convention website (UNEP n.d. b).

The Parties to the Basel Convention adopted the Basel Convention Technical Guidelines for the Environmentally Sound Management of Waste Lead Acid Batteries in 2003, providing guidance on how to ensure the ESM of waste lead acid batteries.

The ESM toolkit developed by an expert working group on ESM includes a fact sheet on waste lead acid batteries. The toolkit provides useful references on topics including classification, collection, storage, packaging, transport, ESM, extended producer responsibility, certification, and auditing (UNEP n.d. c). For further information on how WLABs can be packaged and prepared for transport, please see Section 4 of this Guidance Manual.

In accordance with the Basel Convention, the exporter should check that the waste in question has been appropriately processed and the environmentally sound disposal certified. Prior to the movement, the exporter or generator (if acting as the notifier) will work with the pertinent authority¹ of the State of export to make sure that:

- The States of import and export are both Parties to the Basel Convention or have entered into a bilateral, multilateral or regional agreement or arrangement in accordance with Article 11 of the Basel Convention and that the transboundary movement only takes place between the States of export and import.

- The States concerned with the transboundary movement have not been banned or restricted in any way.
- That the export or import of WLABs is not prohibited through other means (e.g., if the States concerned are Parties to the Bamako Convention, national decisions to prohibit or restrict import, transit, or export, etc.) (UNEP n.d. d).
- The State of export also needs to take appropriate measures to ensure that the movement of the WLABs is only allowed if: the State of export of the WLABs does not have the technical capacity and the necessary facilities to dispose of the WLABs in an environmentally sound and efficient manner; the WLABs are required as a raw material for recycling or recovery industries in the State of import; or the movement is in accordance with other criteria decided by the Basel Convention Parties.
- The importer and other relevant stakeholders involved in the movement are acting in accordance with any national requirements of the State of import (e.g., licensing and the management of the WLABs will be environmentally sound).

A contract must be signed between the exporter and the disposer in the State of import specifying the ESM for the wastes in question (UNEP 2014). The contract should specify the contract period, the dates of arrival at the country of import, the treatment associated with the recycling processes, the quantities of WLABs, and the packaging to be used, as well as document that the appropriate liability, insurance, and financial arrangements have been made.

There might also be further requirements that need to be put in place under the national laws and other measures in the States concerned with the movement. The State of import or State of transit that is a Party may require the transboundary movement be covered by insurance, bond or another such guarantee (paragraph 11 of Article 6).

The Basel Convention also requires that the State of export shall notify in writing or shall require the generator or exporter of WLABs to notify through the channel of the competent authority² of the State of export, the competent authority of the States concerned regarding any proposed transboundary movement of WLABs (paragraph 1 of Article 6).

1. A complete list of Country Contacts is available on the Basel Convention website at www.basel.int/Countries/CountryContacts/tabid/1342/Default.aspx
 2. A complete list of competent authorities is available on the Basel Convention website at www.basel.int/Procedures/CompetentAuthorities/tabid/1324/

Section 2

Such notifications should contain the declarations and information specified in Annex V of the Convention, but be aware that additional information may be required depending on the States concerned (UNEP 2011). The notification needs to be written in a language acceptable to the State of import. Only one notification needs to be sent to each State concerned, although for certain movements, a general notification may be sufficient. The exporter must contact the competent authority in the State of export to initiate the paperwork process of notification and movement through the channel of the competent authority of the State of export (UNEP n.d. b).

2.4 Basel Convention Ban Amendment

On December 5, 2019, the Basel Convention Ban Amendment entered into force (UNEP 2019). The Ban Amendment prohibits the export of hazardous wastes from member States of the European Union (EU), the Organization for Economic Cooperation and Development (OECD), and Liechtenstein to all other countries. The Ban Amendment could affect the transboundary movement of WLABs, so it is important to note the following points:

- While the Ban Amendment is only binding on those Parties that have agreed to be bound by it, there is an obligation on all Parties to respect and comply with the import restrictions and prohibitions of other Parties.

- Parties to the Basel Convention can also decide to exercise their right to prohibit the import of hazardous waste or other waste, including WLABs, under Article 4. These decisions can be communicated to the other Parties through the Secretariat at any time during the year or through the national report transmitted before the end of each calendar year. The Secretariat makes these available on the Basel Convention website (UNEP n.d. d). Such notifications, in turn, lead to an obligation from the State of export to restrict the export of hazardous wastes or other wastes from Parties that have prohibited the import.

2.5 The Bamako Convention

The Bamako Convention, adopted by 51 African nations, was originally negotiated through the Organisation of African Unity (OAU) and has been in force since 1998. As of June 2021, it has 29 Signatories and 25 Parties that have ratified the Convention (UNEP n.d. e). It is a treaty that prohibits the import of any hazardous waste, including WLABs, from outside the African continent into any country in Africa, including those island nations that are members of the OAU and signatories to the Bamako Convention.



Figure 1: The Banks of the Volta River, Ghana (Courtesy of ILA).

However, the Bamako Convention does not ban the trade in hazardous waste between Parties and signatories to the Bamako Convention. Nevertheless, the Convention does require those countries that are Parties to make every effort to minimize the amount and extent of any transboundary movement of wastes and to only conduct such trade with the consent of the importing State and, if applicable, the transit States, by applying the necessary PIC control protocols from the Basel Convention. Nations are also obliged to minimize the production of hazardous wastes and to cooperate with the OAU member States to ensure that wastes such as WLABs are treated and recycled in a safe and environmentally sound manner.

The Bamako Convention also requires each nation that has ratified the Convention to apply a preventive and precautionary approach to pollution problems. This means that there is an obligation for the African member nations to prevent the release into the environment of substances that may cause harm to humans or damage the environment. The Convention promotes a collaborative approach toward the environmentally sound management of WLABs and discourages last-stage or “end-of-pipe” solutions, which aim to remediate contaminant flows just before they enter the environment. It should be noted that the Bamako Convention does not replace the Basel Convention, but instead strengthens it.

2.6 Domestic Legislation

Most African countries have legislation in place that is intended to be protective of human health and the environment. When developing measures to promote the ESM of WLABs, it is important to consider national legislation pertinent to each stage of the WLAB supply chain, occupational health and safety, and the protection of human health and the environment (UNEP 2016).

Although it is beyond the scope of the Guidance Manual to review such legislation in each African country, it should be noted that for the most part, following and applying the Basel Convention Technical Guidelines for the ESM of WLABs by all the Parties in Africa would help to improve the implementation of the obligations of the Parties to the Convention. The main challenges most countries face are the licensing processes, Health, Safety, and Environmental (HSE) monitoring, and enforcement of such legislation where the inspectorate and enforcement authorities may be or is under-resourced.



Courtesy of Brian Wilson / SRI Ghana

Section 2

African States may wish to consider incorporating the following into their national frameworks as appropriate:

- Measures that impose a duty of care on companies and any person concerned or involved with either handling, recycling, or disposing of hazardous waste shall do so in an environmentally sound manner that is also safe and hygienic. This also contributes to implementing one of the obligations under the Basel Convention to prohibit all persons in its jurisdiction from transporting or disposing of wastes unless authorized or allowed to perform such operations. Such measures could apply to any natural or legal person that produces, processes, imports, exports, transports, trades, stores, or disposes of a controlled or hazardous waste, or owns or otherwise controls a property on which hazardous waste is managed.
- Guarantees to ensure the occupational health and safety of employees, contractors and others handling WLABs. In Ghana, for example, that right is enshrined in the 1992 Constitution's Article 36, which says, "The State shall safeguard the health, safety, and welfare of all persons in employment." Similarly, in the Republic of South Africa, the 1996 Constitution provides the right of its citizens to their health and safety in the workplace.
- The right of every citizen to live in a healthy environment in the present and the future. A good example is in Kenya, where every citizen is guaranteed the following under Article 42 of the nation's Constitution: "Every person has the right to a clean and healthy environment, which includes the right to have the environment protected for the benefit of present and future generations through legislative and other measures."
- Enforcement mechanisms and measures should be put in place so that those who break laws relating to the handling, disposal or recycling of hazardous waste pay reparation for the damage to the environment or suffering caused to communities, workers or citizens, to the extent that the redress restores the situation to pre-breach conditions to the extent possible.
- WLAB recycling should be managed in a manner that is environmentally sound. Standards for atmospheric emissions, effluent discharges, and occupational lead exposure should be enshrined in law and regulations.
- Measures that protect and safeguard the national environment for present and future generations in a spirit of cooperation with other States and bodies for the purposes of protecting the wider international environment for humanity. Such measures should require companies and citizens that generate hazardous waste, such as WLABs, to dispose or recycle the waste in a sustainable and environmentally sound manner such that the disposal or recycling process protects the environment, native flora, indigenous fauna, and drinking water sources for present and future generations. For example, the Ghanaian Constitution under Article 36 states: "The State shall take appropriate measures needed to protect and safeguard the national environment for posterity; and shall seek cooperation with other States and bodies for the purposes of protecting the wider international environment for mankind."
- A licensing and authorization procedure for any person or persons involved in handling hazardous waste that requires an on-site HSE assessment by the appropriate government enforcement/regulatory agency. For example, the EPA in Ghana commenced site inspections in 2017 (SRI 2017). In this manner, the country is also ensuring that it meets one of the obligations under the Basel Convention to prohibit all persons in its jurisdiction from transporting or disposing of wastes unless authorized or allowed to perform such operations.
 - » It should be noted that standards for atmospheric emissions, effluent discharges, and occupational exposure, the laws reference should be based on the latest scientific advice published by the WHO and the U.S. Environmental Protection Agency (EPA) (WHO 2021; EPA n.d. a). Furthermore, standards should be regularly reviewed at least every five years in a manner akin to the Stockholm Convention on Persistent Organic Pollutants (Article 5(a)v) (UNEP 2004).

For those employed in the WLAB sector, the frequency of workers' occupational exposure testing should also be specified and should occur regularly at least twice a year (U.S. Department of Labor n.d.).

Section 3

Assessing and Promoting the ESM of WLABs at the National and/or Regional Level

This section of the Guidance Manual outlines steps that should be put in place to assess the status of WLAB management and formulate a strategy for ESM of WLABs in a particular country or region. Note that a thorough explanation of the steps is beyond the scope of this Guidance Manual. However, the steps are detailed in full in the Basel Convention Training Manual. A number of these elements are reflected herein in a Case Study for Ghana, as well as in Case Studies for Tanzania and Burkina Faso, found at the conclusion of this section.

3.1 Analyze Current WLAB Management

- » Complete an inventory and trade analysis to ascertain how many LABs are in use and how many WLABs are generated annually. The complete procedure for the development of a LAB/WLAB inventory is included in the practical guidance for the development of such an inventory, developed and published by the Basel Convention (UNEP n.d. f). The inventory and trade analyzes are based on:
 - » Domestic generation/production and use of LABs
 - » Exports of domestically produced LABs
 - » LABs and lead imports into the domestic market
 - » Domestic use and annual consumption of LABs
 - » Tonnages of LABs in use
 - » Useful life of LABs in each application
 - » Trading value of the LAB industry sector in USD or local currency

(see example case studies below for Tanzania and Burkina Faso)

- Determine quantities of WLABs being collected and recycled:
 - » Domestically
 - » Exported to be recycled
 - » In the formal, licensed recycling sector
 - » In the informal, unlicensed recycling sector (from a survey or by difference between the amount recycled by the formal sector and the projected or calculated amount of WLABs generated annually)
- Review international and national legislation pertinent to the ESM of WLABs and:
 - » Identify the hazardous waste management legislation and regulations pertinent to WLABs.

- » Check whether the country is a Party to the Basel Convention and the prior informed consent process is in operation for WLAB imports and exports.
- » Ascertain what licensing and authorization procedures are in place for waste management operations, in particular the transboundary movement of hazardous waste and if possible specific to WLABs.
- » List all occupational health, safety, and environmental legislation applicable to the manufacturing and recycling sectors of the lead industry.
- » Identify any legislative gaps or inadequacies in HSE legislation.

- Evaluate national and regional infrastructure and capacity for the ESM of WLABs in the recycling sector:

- » Collection, transportation, and storage facilities
- » Recycling facilities
- » Refining facilities
- » LAB manufacturing and other users of secondary lead from WLABs
- » Waste management and waste recycling facilities (e.g., plastic cases, sulfuric acid)

3.2 Prioritize and Assign Roles and Responsibilities for Managing Various Aspects of the ESM of WLABs

- Government agencies responsible for:
 - » Occupational health and safety
 - » Hazardous waste transportation and management
 - » Protection of human health and the environment
 - » Finance and trade
 - » Taxation
 - » Enforcement and inspections
- Domestic and overseas LAB generators, exporters, importers, and disposers of waste
- LAB importers and retailers
- End users of LABs
- WLAB collectors, transporters and recyclers
- Civil society, NGOs and academia

Section 3

3.3 Prepare and Implement a Strategy to Promote the ESM of WLABs

Once all the data and information required for the LAB/WLAB inventory and trade analysis has been compiled and analyzed and the stakeholders advised of their roles and responsibilities, a comprehensive strategy to promote the ESM of WLABs in the recycling sector can be formulated. It is essential that such a strategy is based on a domestic legislative framework and consistent with any obligations required to implement and enforce international conventions, such as the Basel and Bamako Conventions, for:

- Hazardous waste management, ensuring that WLABs are included in the Hazardous waste category of any legislation and guidance documents for collection, storage, transportation, recycling or disposal.
- Emissions to atmosphere, including standards for lead particulates, sulfur dioxide and nitrogen oxide gases.
- Effluent discharges, including standards for pH (7- 9), dissolved and suspended lead, and any other toxic substances.
- Occupational health and safety, including lead in blood restriction and suspension levels for men and for women, especially of childbearing age.
- Provisions for licensing and monitoring environmental performance, such that any company or business

involved in the recycling of WLABs must pass an HSE assessment by government regulators before an operating license is issued. An operating license should be time limited (for example, one or two years), and then renewed subject to an HSE inspection.

- Incentives to promote the ESM of WLABs, such as deposit/ refund take-back programs designed to encourage the users of LABs to trade in WLABs to a registered retail outlet or dealer that guarantees to send all WLABs to a formal, environmentally sound recycling plant.
- Public awareness and education campaigns, informing users of the adverse health and environmental impacts of improper WLAB recycling and to encourage users to ensure that WLABs are disposed of within the formal sector.
- Corporate social responsibility on the part of the industry sector, such that LAB manufacturers and importers are legally responsible through the introduction of extended producer responsibility (EPR) for the ESM of any LAB they produce or import and sell on the domestic market.
- Measures such as EPR, which help to eliminate unsound informal recycling through the introduction of a closed-loop life-cycle approach to LABs and WLABs that keeps the informal sector out of the loop (Figure 2 below).

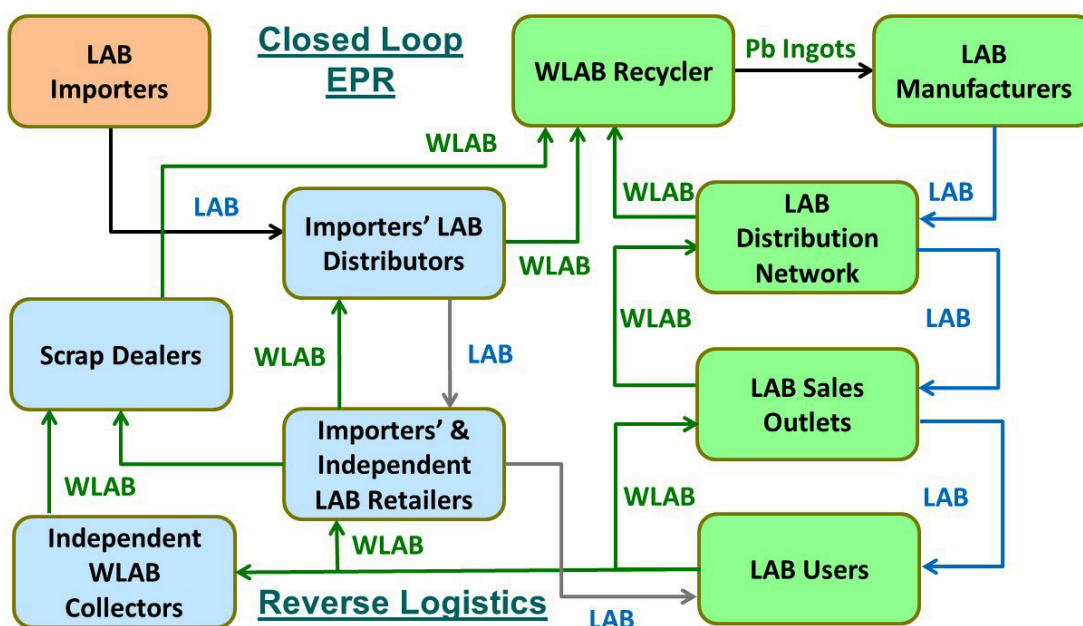


Figure 2: LAB life cycle chart for a country with domestic LAB manufacturing and imports (Courtesy of the ILA).

A sound legislative framework should embrace and cover the whole WLAB supply chain (collection, storage, transportation, recycling, refining, and waste management), including a licensing and control system for stakeholders involved in the management of WLABs. Furthermore, there should be appropriate penalties laid out for any company or individual that supplies any informal recycler or unlicensed trader with a WLAB.

The legislative framework should provide the basis for a mechanism to implement and enforce the Basel Convention, including measures to prevent and sanction conduct or procedures in contravention with the relevant HSE legislation. Legislation can also include elements related to EPR, which should place the responsibility for the ESM of WLABs and full HSE compliance with the LAB manufacturer or importer.

Legislation provides the legitimacy for prosecuting any informal unlicensed WLAB recycling operations, but it is also critical to facilitate and encourage the sound management of WLABs by formal licensed recyclers. Legislation also facilitates information exchange or compilation and cooperation between different stakeholders.

However, governments should also consider introducing economic incentives for the formal WLAB recycling sector, such as:

- Deposit/refund initiatives to promote WLABs being directed into the formal sector.
- Green deposit taxes for replacement LAB sales that can be reclaimed only by a licensed, environmentally sound recycler.

For example, the government in Ghana has imposed a significant levy on the price of new LABs. This levy can only be reclaimed by licensed, environmentally sound WLAB recyclers. The levy is high enough to provide the licensed recyclers with a financial advantage over the informal sector because the informal sector cannot reclaim the levy. This financial tool effectively keeps the informal sector out of WLAB recycling.

In addition, WLABs that are bought for domestic recycling or recycling in a designated regional hub may be exempted from sales tax, value added tax (VAT), or goods and services tax (GST). Informal recyclers do not normally pay any taxes, so if WLAB purchases in the formal sector are subject to GST or VAT, payment of the tax places the formal recycler at a cost disadvantage in any bidding contest. A government that provides effective support for the formal recycling sector could also benefit from the tax revenues on profits, which would not be paid by informal recyclers.

3.4 Monitor and Scrutinize the Implementation of Policies and Strategies to Manage WLABs

The effectiveness of laws, regulations and policies aimed at facilitating the ESM of WLABs will depend, in large part, on the effectiveness of the appropriate monitoring and enforcement programs.

In this context it is recommended that consideration is given to having:

- A licensing procedure for WLAB recycling operations that includes periodic monitoring and evaluation of each of those sectors for compliance with applicable HSE compliance.
- Biannual, full-scale HSE compliance audits for recycling plant atmospheric emissions and effluent discharges.
- A minimum of biannual medical surveillance in WLAB operations for occupational blood lead levels (BLLs), including more frequent testing for any pregnant employees and removal from exposed work areas for a designated period for any employee or contractor over the recommended BLL.
- Biannual perimeter sampling for lead in air values.
- HSE site assessment for WLAB collectors, dealers, and traders.
- Licensing requirements for companies or individuals involved in WLAB transportation.

CASE STUDY IN GHANA:

Setting, Monitoring, and Enforcing Environmental and Occupational Health Standards for WLAB Recycling

In 2016, at the invitation of the Ghanaian Environmental Protection Agency (EPA), the Sustainable Recycling Industries Group in Ghana (SRI) prepared an inventory of the amount of lead acid batteries in use in Ghana and estimated the tonnage of waste lead acid batteries generated annually (Atiemo *et al.* 2016).

Initial inspections of the four licensed companies in Ghana by the enforcement branch of the EPA identified shortcomings in safe working procedures and environmental control systems, but they were unable to recommend specific improvements. Nevertheless, in July 2017, the managers of three of the secondary lead smelters signed commitments to work with the EPA to improve the HSE performance at their respective operations.

The Director for Standards and Compliance Enforcement at EPA and the focal point for the Basel Convention in Ghana, stressed that “it is not enough to ask only one facility to improve. We want the whole industry to improve and to come to a fair and level playing field based on ambitious environmental standards. Ghana needs an active recycling industry, but profits should not be made on the expenses of public health and the environment.”

Accordingly, the EPA engaged the Ghanaian SRI, the Oeko Institute, and the International Lead Association (ILA) to conduct a hands-on workshop to train EPA personnel and staff from the Factories Inspectorate Department (FID) on how to conduct HSE assessments of WLAB recycling plants. In addition, the production managers from three WLAB recycling plants were also invited to attend the training sessions.

At the workshop held in July 2017, delegates learned how WLABs can be recycled in a sustainable, financially viable, hygienic, safe, and environmentally sound manner using technologies readily available in Africa. The delegates learned how to apply an assessment tool to check the HSE performance of a WLAB recycling operation, and they also conducted simulated virtual plant inspections to test their understanding of the use and application of the assessment tool throughout the supply and recycling chain for WLABs.

The delegates then used the assessment tool during real-time inspections at the four recycling plants in Accra and Tema. The regulators used their freshly gained knowledge and skills to present their observations to representatives of the recycling plants. They also prepared improvement plans to reduce emissions and provide a safe environment for the workers’ wellbeing.



Figure 3: Workshop participants for the ESM of WLABs (Courtesy of the ILA / SRI Ghana).

All of the companies that participated in the workshop indicated their support for the plans and agreed to work in partnership with the EPA on all the recommended improvements identified during the workshop field exercises. One of the resource experts who attended the workshop from the Basel Convention Coordinating Centre (BCCC) in Nigeria⁹ stated that the workshop was most informative and practical, but that above all, the industry leaders' commitment to the EPA to improve HSE performance is unique in the region. He also went on to say that "comparable efforts and strategies are necessary in many more countries within the region, and I hope that Ghana will now demonstrate how to successfully green this recycling industry."

Factors that Led to Success

The growth of green energy and the increase in vehicle populations in countries such as Ghana have increased demand for lead acid batteries, and they remain a most reliable and cost-effective solution for energy storage. The growth of LAB consumption means more WLABs, and in that context this project was a success because:

- HSE inspectors and regulators understood how WLABs can be recycled in a hygienic, safe, and environmentally sound manner.
- HSE inspectors were trained to undertake informed assessments of WLAB recycling plants' HSE performance.
- Partnership and constructive fact-based dialogue between local government agencies, industry, and NGOs proved to be the best way to ensure that sustainable and environmentally responsible battery recycling becomes the norm in every country.

1. More details on BCCC Nigeria can be found on the Basel Convention website at <http://basel.int/?tabid=4833>

How a LAB and WLAB Inventory and Trade Analysis Provided Essential Information for the Development of National Strategies for the Management of WLABs

When a government is considering the introduction of effective policies and strategies for the ESM of LABs and WLABs, it is key to note that Parties to the Basel Convention have an obligation to take appropriate measures to ensure the availability of adequate disposal facilities for the ESM of hazardous and non-hazardous wastes within their territories. They must also ensure that the transboundary movements of hazardous wastes and other wastes are reduced to a minimum consistent with the environmentally sound and efficient management of such wastes. This means that at an early stage in the development of policies and strategies, consideration must be given to recycling options. There are essentially three recycling options for a government to consider when developing a national strategy and supporting policies for the environmentally sound management of used lead acid batteries:

1. Domestic recycling
2. Recycling through a regional hub
3. Exporting to a country in another region of the world, bearing in mind the obligation to minimize transboundary movements under the Basel Convention

In order to select the most appropriate option, governments need to know six key data sets:

- The amount of lead acid batteries consumed annually and the tonnage of WLABs generated each year
- Legislation and other measures that support the ESM of WLABs
- Legislation or fiscal policies and any measures that undermine the ESM of WLABs
- The amount of LABs manufactured domestically and the amount imported
- How WLABs are either domestically recycled or exported for recycling
- The location and capacity of all domestic and regional WLAB recycling plants

- The environmental performance of domestic and regional recycling plants
- Most of the data and information can usually be found online. Likely sources include:
 - Government vehicle registration databases.
 - UN Comtrade database for the import and export of LABs, WLABs and refined lead ingots by weight (UN n.d.).
 - Government green energy websites listing solar home and commercial systems that use LABs for energy storage.
 - Government websites that list licensed WLAB recycling plants.
 - Government websites that detail legislation relating to the ESM of WLABs.
 - Third-party surveys and studies on the recycling of WLABs.
 - International Lead Zinc Study Group's (ILZSG) database of primary and secondary lead smelters (ILZSG n.d.).
 - Telecom websites that show the number of relay stations with LAB back-up systems.

Collecting and collating the necessary data and information can be difficult. For Burkina Faso and Tanzania, there were several common challenges to overcome. For example:

- Governments generally do not know the extent of informal, unlicensed WLAB recycling activity.
- UN Comtrade data is not always accurate because some lead products, such as WLABs, are not always labelled correctly.
- The data and information displayed on government websites is not always up to date.

The Burkina Faso and Tanzania data and information gaps were filled in several ways:

- Local personnel visited relevant government ministries, energy providers, and telecoms companies to solicit information about LAB consumption and WLAB disposal.
- Formal and informal WLAB plants were visited to ascertain the environmental state of the site and whether the operations were properly licensed and approved by the government.
- Scrap dealers and traders in WLABs were asked about the domestic recycling or export of the WLABs collected.
- Comtrade LAB, WLAB, and lead ingot import and export data was cross-referenced with all other countries in the world. For example, WLABs exports from Burkina Faso and Tanzania for a given year were cross-referenced against WLAB imports from Burkina Faso and Tanzania for every country in the world.

The Burkina Faso LAB and WLAB inventory and trade analysis established four key elements:

- There are no licensed WLAB recycling plants in the country.
- WLAB collectors, traders, and the Comtrade data all provided evidence that WLABs are exported to Ghana for recycling.
- Any informal recycling is minimal, but where it exists, the working conditions are poor.
- There are insufficient WLABs generated annually for a formal WLAB plant to be financially viable.

The facts suggest that the most appropriate national strategy for the ESM of WLABs from Burkina Faso is to export to a licensed and environmentally sound recycling plant in Ghana in compliance with the Basel Convention obligations.

In the case of Tanzania, the LAB and WLAB inventory and trade analysis established four key points that contrasted to the findings in Burkina Faso:

- There are three licensed WLAB recycling plants in the country.
- WLAB collectors, traders, and the Comtrade data support the fact that most of the WLABs are recycled in Tanzania.
- There is no evidence of any informal recycling.
- There are sufficient WLABs generated annually for formal WLAB recycling to be financially viable.

The findings of the Tanzania study suggest that the most appropriate national strategy for the ESM of WLABs is domestic recycling through any of the licensed and environmentally sound recycling plants in Tanzania.

The different national strategy recommendations for Burkina Faso and Tanzania demonstrate the value of preparing a LAB and WLAB inventory and trade analysis.

Section 4

Environmentally Sound Management of Waste Lead Acid Batteries in the Licensed Sector

Some of the key components necessary to achieve the goal of the ESM of WLABs along the supply chain are highlighted in this section, with other components (e.g., legislative, occupational health and safety, etc.) introduced later in this Guidance Manual.

It is important to note that the WLAB recycling industry includes not only informal backyard-type operations and well-run formal facilities, but also everything in between. While the most severe environmental and health risks associated with WLABs often result from unsound recycling in unlicensed, informal sector operations (see Section 6), many licensed, formal sector WLAB recyclers operate substandard facilities that release large volumes of lead-laden emissions, generate and poorly manage contaminated wastes, and expose workers to the dangers of lead exposure and other possible toxins. However, environmental and health risks are not just associated with recycling facilities themselves, they exist along the entire WLAB disposal and recycling supply chain.

4.1 WLAB Collection, Storage, and Transportation

The goal is collecting, storing, and transporting 100% of the WLABs generated in a particular country to a licensed recycling plant in an environmentally safe manner. Implicit in this goal is the disposal of all of the collected WLABs in a licensed, environmentally sound recycling facility, as outlined in this section. WLABs can be collected from LAB retail sales outlets, LAB distributors, garages, telecoms companies and government offices. Irrespective of how and where the WLABs are collected, the HSE requirements are the same.

- The electrolyte should not be drained from the WLABs before transportation to the recycling plant, because it is classified as a Hazardous Waste under the Basel Convention, and illicit dumping of a hazardous waste is illegal and impactful to the environment. The Basel Convention fact sheet for WLAB states, "Batteries should be collected with proper care and should be stored whole at collection points. Batteries should not be drained, dismantled or broken to remove lead plates or electrolyte. Draining needs to be handled at licensed, permitted or authorized dismantlers or smelters, who have proper procedures in place to collect and manage the acid."

- When WLABs are prepared for transportation whether in a container or on a pallet, they should be arranged in layers of equal height to minimize movement during transit. Palletized WLABs should be shrink-wrapped in plastic and strapped to minimize any movement during transit.
- If the WLABs are stacked on a pallet, the corrugated cardboard layered between new LABs delivered to retailers should be placed between each layer of WLABs to minimize movement and absorb any electrolyte that might leak during transport.
- The positive terminal or post of the LAB (normally a red mark identifies the positive terminal) should be taped with insulating tape to prevent any short-circuiting during transit.
- Ideally, all LABs should have the terminals or posts recessed into the top of the battery such that the terminals do not protrude. This prevents the terminals from puncturing the case of a WLAB placed on top of it during transport.
- WLABs awaiting transport to a recycling plant should be kept in an upright position and stored in a well-ventilated room on an impermeable, acid-resistant floor.

Appropriate health and safety measures must be taken into consideration when handling WLABs, and appropriate

personal protective equipment (PPE) must be used. The metallic lead and the lead paste in WLABs are toxic. The electrolyte is dilute sulfuric acid, which is not only toxic, but also corrosive.

These are two of the hazardous characteristics listed in Annex III to the Basel Convention.

To reduce the risks of injury through ingestion and splashes when handling WLABs, appropriate PPE must include safety goggles or glasses, a dust mask, neoprene gloves, and overalls. WLABs are heavy; therefore, to minimize crush injuries, both heavy-duty gloves and boots with toe protection must be worn.

Note that occupational health and safety procedures pertinent to other components of WLAB management and recycling are addressed in Section 3.

It is essential that face-fitting respirators provide a tight seal around the face because a respirator cannot protect the wearer if it leaks. A major cause of leaks is a poor fit. People come in all shapes and sizes, so it is unlikely that one type or size of respirator will fit everyone. Fit testing will ensure that the equipment selected is the right shape and size for the wearer (HSE 2019; Shepard 2021).

Prior to transport, WLABs should be inspected for damage by workers wearing the appropriate PPE and should be packaged by either:

- Stacked on a pallet, shrink-wrapped, and strapped, as in Figure 5.
- Stored in a UN 2794 certified container, which offers these assurances:
 - » The container has a leakproof design.
 - » It can be used in any vehicle, not only one licensed to carry hazardous waste.
 - » It is lightweight.
 - » It is forklift-friendly.
 - » The containers are stackable.
 - » They are reusable and recyclable.

Ideally, WLABs should be stored under cover to prevent weathering and any leakage of electrolyte into the environment, as shown in Figure 7, but if a WLAB collector does not have a suitable outbuilding, a collapsible WLAB UN 2794 Certified container could be stored outdoors if weather resistant.

WLABs are classified as a hazardous waste under the Basel Convention and regulated by UN 2794 as dangerous goods under Class 8. Corrosive waste material, i.e., the electrolyte which is an acid, can spill and cause personal injury and property damage. Figure 8 shows two typical HAZMAT Class 8 labels that are commonly seen on vehicles transporting WLABs. The transportation rules are common sense. Essentially, any vehicle transporting WLABs must display the appropriate HAZMAT decals and an emergency contact phone number for use by the emergency services in the event of an accident or spillage. In addition, containers or pallets of WLABs must be chocked or strapped in or on the vehicle to ensure minimal movement during transit.

HSE Risks	Classification	Pathway	PPE
Lead and Acid	 	Ingestion Spill and Splash	   
Lead – It's Heavy			 

Figure 4. WLAB Collection – Health and Safety Risks, Pathways and Mitigation (Courtesy of the ILA).



Figure 5. Stacked WLABs in transit from St. Lucia to Venezuela via Trinidad (Courtesy of the ILA).



Figure 6. UN 2794 Certified leakproof container for WLABs (Courtesy of the ILA).



Figure 7. WLABs in a covered storage shed in Tanzania (Courtesy of Phenix Recycling).

Section 4

4.2 LICENSED SECTOR RECYCLING FACILITIES

4.2.1 Location

Governments and stakeholders must carefully consider the location of existing or planned/proposed formal recycling facilities to minimize the potential for human health and environmental impacts. Ideally, a WLAB recycling plant should be located at a site that:

- Is in a designated Industrial Zone with adequate space to expand.
- Has reliable utilities, water, fuel, and electricity.
- Is close to and links with a good road network.
- Has stable topography and no history of flooding.
- Has no farmland in the immediate vicinity.
- Has no sensitive flora or fauna in the area.
- Is not near hospitals, food outlets, farmland, schools, community housing or water sources.

4.2.2 Operations

The most energy-efficient WLAB recycling option involves breaking the batteries with an automated crusher and

separating the grid metallics and the battery paste. The preference is to use a twin furnace operation, with one furnace dedicated to smelting battery paste to produce a lead bullion that is close to pure lead and requires a minimum of refining. The second furnace can be used to melt the grids at a low temperature to produce a lead alloy suitable for making more grid alloys. Melting the grids takes a lot less time than smelting, so the second furnace will have spare capacity. When it is not melting grids, the second furnace can be used to process baghouse dust, refining drosses, and any other lead-bearing by-products. If WLAB throughput is insufficient to justify a twin furnace operation, the metallics and the paste can be run through a single furnace.



Figure 8. Two typical UN 2794 HAZMAT Class 8 decals commonly seen on vehicles transporting WLABs.

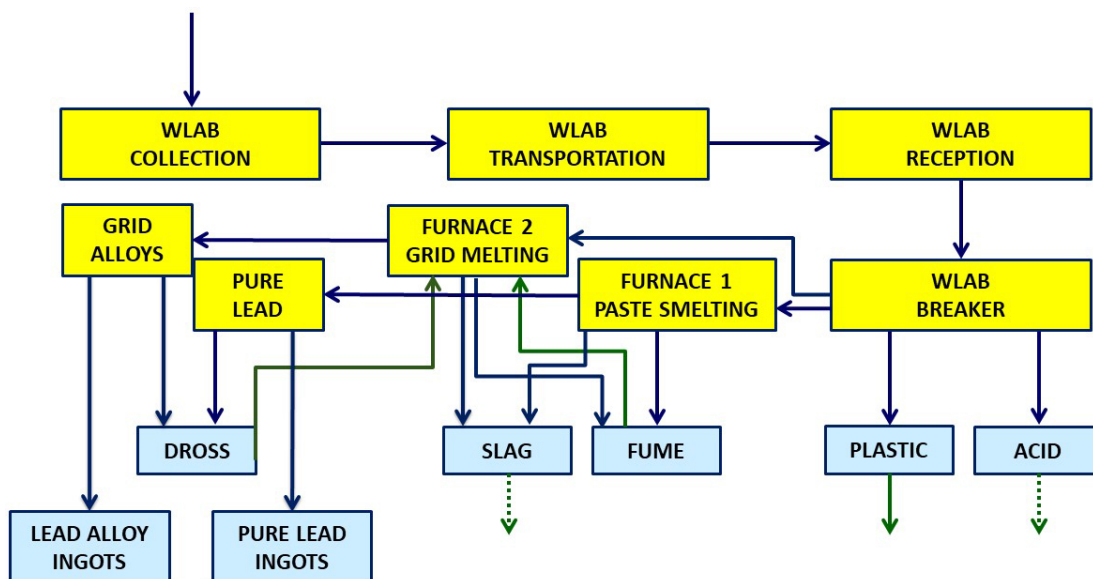


Figure 9: Mechanical WLAB breaker and twin furnace operation for metallics and paste (Courtesy of the ILA).

There are many competing WLAB breakers and pyrometallurgical furnace technologies designed for processing WLABs. This Guidance Manual provides the principles for deciding which technologies are appropriate to ensure environmentally sound management of the process. Keep in mind:

- The WLAB breaker must be capable of crushing all automotive and industrial WLABs.
- The WLAB breaker must be integrated with an effluent treatment plant (ETP) to process the battery electrolyte.
- The furnace or furnaces must be capable of processing all of the expected WLAB throughput and all the process by-products, such as lead dust and refining drosses.
- Furnaces must be connected to a baghouse capable of containing all fugitive emissions.
- The ducting from the furnace must be fitted with a spark arrestor and be sufficiently long enough for the fume to condense to dust, so it can be collected by the filter media.
- A scrubbing tower should be included to remove any residual sulfur dioxide.

The tried and tested process of dust capture incorporates the use of a filter plant or baghouse. Filtration processes can vary among ceramic filters, fabric filter bags, and electrostatic precipitators, but the principles are the same.

Essentially, there is a fan with a high extraction rate that will draw the off gasses from the furnace through a combustion flue and into a drop-out chamber that slows down the particles, giving the fume time to condense into dust. The gasses and dust then pass through a filter medium that removes the dust particles. The gases that pass through the filter medium, which should be dust-free at that point, are then ejected into the atmosphere through a chimney stack. Traditionally, two filter banks are installed so that one is in operation and the other is being cleaned.

Typically, fabric filter bags will capture dust at 25 microns, but recent developments in filter media have led to the introduction of bags that can filter particulates down to 5 microns. If fabric filter media are used, it is critical to cool the off gasses to promote condensation of the fume to dust, then promote growth of the dust particles to a size that can be captured.

Local climatic conditions must be considered when designing the baghouse dust extraction collection system.

Baghouse dust is ejected from the baghouse through non-return valves and is collected in sealed drums or containers, then charged directly to the furnace to recover the lead in the dust.

Wet and dry electrostatic precipitators can capture particulates down to 0.1 microns and require little maintenance, but compared to bag filter plants, they are very expensive.

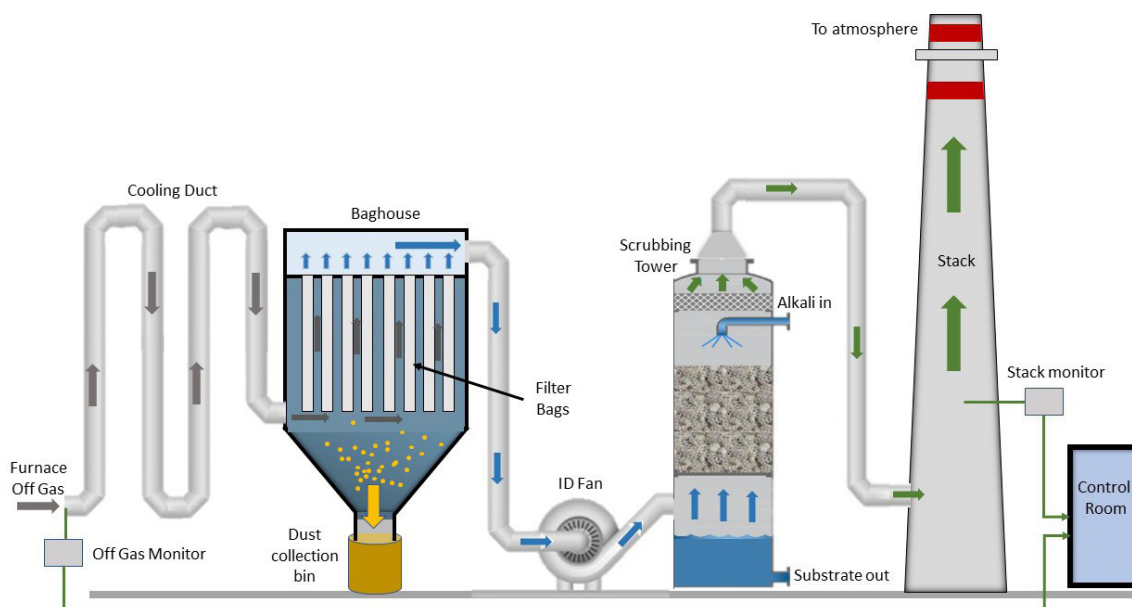


Figure 10: Schematic of a typical filter plant, or baghouse, designed to capture lead dust. (Courtesy of the Oeko Institute, ILA and SRI Ghana)

Section 4

4.2.3 Waste Management

A variety of by-products are generated at WLAB recycling facilities, (see Figure 10) such as battery cases, separators, dross, slag, floor sweepings, baghouse wastes, and PPE. Many of the by-products are potentially an important source of additional income for a recycling plant, including the recycling of polypropylene battery cases for use in new cases or other products. Drained and recovered battery acid can be recycled into a range of saleable products, such as gypsum; alternatively, it should be processed through an effluent treatment plant. It is imperative that all waste streams from

a WLAB recycling plant be considered and appropriately managed in accordance with applicable regulations and in a manner that minimizes potential impacts to human health and the environment. For instance, slag from the furnace is highly lead contaminated including containing lead metal beads. Depending on the furnace technology and the smelting reagents, waste slag can also be hygroscopic as well as toxic (see the Nigerian Case Study below for an example). Disposal of slag at a licensed hazardous waste site is an option, but research into stabilizing the slag and converting it into a saleable product is progressing.



Courtesy of Pure Earth

CASE STUDY:

Recycling of Used Lead Acid Battery Slag into Fired Clay Bricks in Nigeria: A Waste-to-Wealth Initiative

For most developing countries, the management of waste slag derived from the recycling of WLABs in large, formal smelting operations is perhaps the most difficult waste management issue. The slag is highly hazardous (typically containing about 2% to 6% lead) and is often disposed of in an environmentally unsound manner. In many cases, unsound recyclers can get away with dumping the waste indiscriminately on land in the vicinity of their facilities due to weak regulations and enforcement. When removal is contracted, efforts are rarely made to track the final disposal process. As a result of these practices and other emissions from the plants, lead contamination is severe in the vicinities of such smelters in various parts of Africa (Onianwa and Fakayode 2000; Adie and Osibanjo 2009; Pure Earth and Green Cross Switzerland 2016; Gottesfeld et al. 2018).

There is no doubt that indiscriminately dumped slag poses a danger to public health and the environment. During precipitation, lead may leach from the slag into subsoil, groundwater, and surface water, while degraded particulates from the deposit can be further transported by wind. Contaminated flora is also easily ingested by wildlife and domestic animals.

Waste WLAB Slag as a Raw Material for Brick and Tile

A pilot project was carried out by researchers at the University of Ibadan, Nigeria, and the Basel Convention Coordinating Centre for the African Region in Nigeria (BCCC Nigeria) involving the inclusion and stabilization of WLAB recycling slag into the local production of fired clay building bricks and tiles. The procedure's first step required the acquisition of the clay and waste slag, followed by a detailed characterization for physiochemical properties to establish suitability for the recycling process. Various mixture ratios of slag and clay were investigated to determine the optimum blend. Next, the materials were taken through the molding process and kiln fired to the appropriate temperature to form glassy building bricks and tiles.

The recycled slag products were subjected to a series of tests to ascertain their chemical and mechanical properties and establish their suitability for construction purposes. It was crucial to also ensure that the products were sufficiently resistant to lead leaching during extreme weather. In this regard, the products were subjected to the standard toxicity characteristic leaching procedure (TCLP) and synthetic precipitation leaching procedure (SPLP) tests. The products passed all tests.

In a later project funded by the Heinrich Boll Foundation, the process was scaled up to produce larger bricks and tiles using the same materials, and artisans were trained in the production process. The project identified various sources of suitable clay, as well as local WLAB recycling facilities where waste slag management remained problematic.

Samples of the recycled slag products were displayed in Geneva during the 2013 Conference of Parties (COPs) of the Basel Convention. The process was patented by the government of Nigeria on March 11, 2015, as NG/PT/NC/2015/962.

This successful recycling of the waste furnace slag into non-leachable, stable, and commercially valuable building materials represents a novel contribution to the sustainable management of this hazardous waste and may serve as a model for waste management in Africa and other countries.

Factors that Led to Success

Factors that led to success in this study include application and rigorous testing of a waste slag stabilization technique using readily available materials and technology that was financially viable.

Section 5

Occupational Health and Safety Procedures for Waste Lead Acid Battery Recycling

This section of the Guidance Manual is focused on occupational health and safety procedures pertinent to the various components of WLAB handling and recycling. While the health and safety procedures and practices outlined below are presented in the context of a formal sector recycling facility, the same procedures and practices should be employed by all actors in both the formal and informal sectors.

The key processes involved in the recycling of WLABs are collection; transportation; reception; breaking, where the plastic case material and the electrolyte are separated from the lead components; smelting, where most of the impurities are removed and referred to the slag and also where fume and dust are generated; and finally, refining, where the last traces of impurities are removed. Note that health and safety considerations for the collection, storage and transportation processes are summarized in Section 4 above.

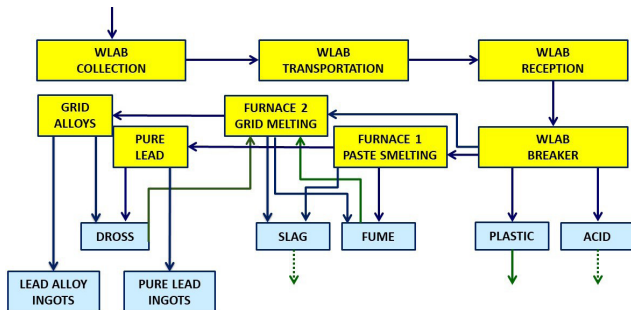


Figure 11: Key WLAB recycling processes (Courtesy of the ILA).

5.1 WLAB Reception

When WLABs reach the recycling plant, safety and occupational health risks must be considered and mitigated. Therefore, metallic lead, lead oxides, sulfates, dilute sulfuric acid, and separators must be contained. Also, WLABs are very often heavy. In order to minimize the risks associated with ingestion, spillage, and crushing, full PPE is strongly recommended. Full PPE consists of a dust mask, gloves, overalls, safety glasses or visor, and boots with toe protection (see Figure 12).

HSE Risks	Classification	Pathway	PPE
Metallic Lead		Ingestion	
Lead Oxides & Sulfates		Ingestion/ Inhalation	
Dilute Sulfuric Acid		Spill and Splash	
Separators	Safe – if clean	Ingestion	
Weight		Hands and Feet	

Figure 12: WLAB Reception – Risks, Pathways and Mitigation (Courtesy of the ILA).

5.2 WLAB Breaking and the Effluent Treatment Plant

WLABs must never be broken or dismantled manually. A far more efficient and safer method is to break the WLABs using a ventilated battery saw or an automated hammer mill crusher (U.S. Department of Labor n.d.).

When using a battery saw, the electrolyte in the WLABs must be drained into an effluent treatment plant prior to it being fed into the battery saw, and the saw blades need to be adjusted to the appropriate height of the WLAB. The saw removes the top cover, and the lead-bearing components can then be released from the battery case. However, the battery saw cannot separate the battery grids from the paste.



Figure 13: Ventilating battery saw. (Courtesy of Gravita, India)



Figure 14: WLAB automated hammer mill breaker. (Courtesy of Green Recycling Industries Ltd., Agbara, Nigeria, and STC, Italy)

An Effluent Treatment Plant (ETP) is required for battery saw and hammer mill breakers. Ideally, the WLABs should

be broken using an automated mechanical hammer mill. Unlike the battery saw, in this process, the WLABs are fed onto the conveyor and into the beaker whole and complete with electrolyte. A manual feed to the conveyor is recommended to ensure that lithium-ion batteries are not charged to the breaker, because there is a serious risk of explosion. The breaker will then separate the plastics, the paste, and the grids through a hydro-gravitational process. The plastic cases, normally polypropylene, are broken into small chips. Before they are ejected from the breaker, they are washed and rinsed to remove any lead oxides.

In addition to the PPE requirements for handling the hazardous wastes, and irrespective of whether a battery saw or an automated mechanical hammer mill is employed to break the WLABs, acid mist will be generated, and the process is extremely noisy.

Modern breakers will have noise damping and should be ventilated, but if that is not the case, a special cartridge that removes acid mist must be used in any respirator. It also might be necessary to wear ear protection if the noise level is above 80 decibels.

ULAB Contains	Classification	Pathway	PPE
Metallic Lead		Ingestion	
Lead Oxides & Sulfates		Ingestion Inhalation	
Dilute Sulfuric Acid		Spill and Splash	
Acid Mist		Ingestion Inhalation	
Noise		Ears	

Figure 15: WLAB Breaking and ETP – Risks, Pathways and Mitigation (Courtesy of the ILA).

5.3 WLAB Melting, Smelting, and Refining Operations

Whether the recycling process involves melting grid metallics, smelting battery paste or refining lead bullion, the health and safety risks are remarkably similar, as are the mitigation measures. Essentially, any furnace used for melting or smelting and any refining crucible requires effective extraction ventilation to a filter plant (baghouse) to capture fugitive lead fume and dust. Ventilated bays with noise suppression should be built for hot metal and furnace residues (slag), or self-contained ventilated remote workstations can be used.

The only safe protection against the smallest lead fume particulates below 0.3 microns is extraction ventilation to a baghouse. Maintenance personnel servicing a baghouse must wear self-contained breathing apparatus. When their work is complete, workers should shower wearing all PPE to remove any residual dust before taking off the PPE and proceeding to the changing rooms.

Section 5

5.4 Housekeeping and Amenity Provisions

- Areas prone to being dusty should be damped down regularly.
- Appropriate PPE commensurate with the health and safety risks should be worn at all times in the workplace.
- Hard hats should be worn in any area with an overhead crane in operation.
- Cartridge dust respirators (minimum FFP2 or N95 standard) should be issued to permanent employees working in any areas other than battery breaking. Cartridge acid respirators should be issued to workers employed in the battery breaking section.
- Where disposal dust masks are in use, they should be used only for a single shift.
- Only respirators fitted with a vent valve should be used. The vent valve prevents the mask from getting wet from exhalation. This is important because once the filter medium is wet, it ceases to be an effective filter. The valve also serves as a voice box, enabling conversations to take place without having to remove the respirator.
- It is essential that operating and maintenance personnel are issued with clean work clothing for every shift.
- Street clothes and work clothing should be separated in the changing rooms. To facilitate this, segregated clean and plant changing rooms should be provided.
- Adequate washing and showering facilities should be available, and clean and plant side washing facilities should be segregated.
- All personnel should be required to shower at the end of their working day or shift.
- Employees must wear only street/home clothing when they leave the plant.
- Operator breaks must be taken in a clean canteen with HEPA- filtered air conditioning.
- Operating personnel must not wear work clothing, respirators, gloves or work boots in the canteen.









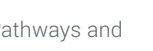
HSE Risks	Classification	Pathway	PPE
Lead dusts		Ingestion Inhalation	
Lead Fume		Inhalation	Effective Furnace Extraction Ventilation
Hot Metal and Slag		Body – Spills, Sparks/Splashes	
Noise		Ears	
Baghouse Maintenance		Ingestion Inhalation	

Figure 16: Melting, smelting, and refining – Risks, Pathways and Mitigation (Courtesy of the ILA).

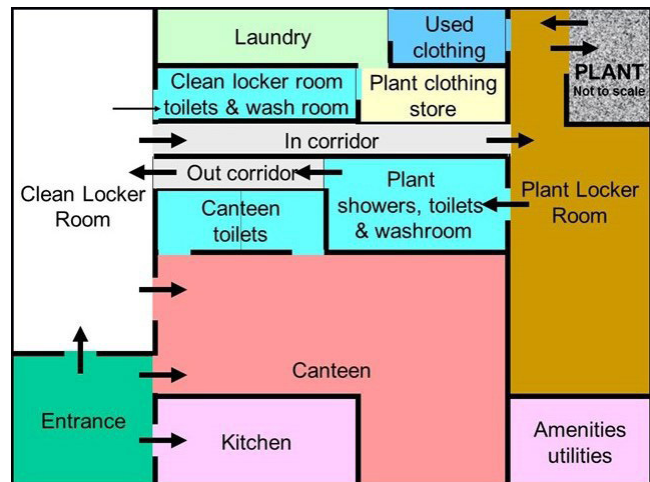


Figure 17: Amenity block with segregated clean and plant services (Courtesy of the ILA).

- It is important to design amenities so that the clean and plant sides are segregated and do not mix.
- Following the segregated pathways through the amenity block, operators and maintenance personnel must enter the amenity block and leave their personal clothing in the clean locker room, then collect their work clothing and put on their PPE in the plant changing room. At the end of the shift or at break time, personnel must follow a reverse procedure, leaving all their work clothing and PPE in the plant changing room, then washing or showering before putting on clean clothes to either go to the canteen or leave the plant.

Section 6

Legislation, Strategies, and Policies for Eliminating the Unsound WLAB Recycling Activities of the Informal Sector

6.1 Introduction

The most adverse environmental and human health impacts resulting from the recycling of WLABs are normally associated with the activities of unlicensed, unauthorized informal recyclers. Informal WLAB recycling is not only found in Africa, but is a global issue. The International Labour Organization (ILO) estimates that about 2 billion workers, or over 60 percent of the world's adult workforce are employed either full or part time in the informal sector (ILO 2016). The ILO suggests that Latin America and sub-Saharan Africa have the highest levels of informal business activity and are predominately in lower- and middle-income countries.

Indeed, the ILO concludes that significant informal activity reduces a nation's social development and economic growth rate below its true potential. It is a vicious circle, because irrespective of the size of any informal business or sector, the fact they do not pay taxes deprives governments of the financial resources to provide their citizens with the basic health care and social services that are available in countries with a good tax regime.

Considering the social impact further, the ILO also concluded that those employed in the informal sector were invariably poorly educated, worked in unsafe conditions and were badly paid compared to those who are well-educated who can secure well-paid employment.

Gender inequality is also an issue in the informal sector because the ILO estimates that worldwide, approximately 58 percent of all the women in paid employment work in the informal sector. The percentage of women in the informal non-agricultural sector in sub-Saharan Africa is around 83%. Furthermore, if the informal sector is formalized and working conditions and pay improves, women can easily find themselves displaced by men – a social factor that has to be considered during any transition (see the TSM Case Study in Section 8).

All the evidence suggests that formalizing informal business activities has benefits for not only the governments of Africa, but the populations employed in the informal sector. The World Bank estimates that in some countries, informal businesses contribute over 50% of a nation's GDP, but the informal businesses tend to be small and, in the case of WLAB recycling, inefficient. Formalizing the informal WLAB sector, for example, will raise environmental standards by reducing lead-bearing emissions and discharge, which in turn, increases the lead recovery rate and raises income and

profits, thereby enabling the business to pay taxes, improve environmental standards and working conditions, and pay higher wages. So there is no loss of GDP; in fact, it should increase.

Nevertheless, to enable governments to formalize the informal sector, there are questions that policymakers and regulators should ask of themselves. For example, "What are the barriers to licensed environmentally sound WLAB recycling?" and "Why is there informal unsound WLAB collection and recycling?"

6.2 Identifying the Barriers to ESM and the Reasons for Informal WLAB Recycling

What are the barriers to the ESM of WLABs or reasons that informal recycling persists? Possibilities include:

- A lack of employment opportunities in well-paid jobs.
- A lack of official government or provincial inspection and enforcement of either the licensing procedure or the HSE legislation.
- Inadequate licensing and HSE auditing procedures.
- The licensed and environmentally sound smelters are too far away for WLABs to be transported economically.
- The fact that reconditioning or recycling WLABs is relatively easy and is seen as a good business opportunity for anyone who is unemployed, regardless of training.
- Informal recyclers can make more money and offer a better price for the WLABs because they are not paying taxes or any environmental overheads.
- Formal licensed recyclers must pay VAT/GST for WLABs and therefore cannot compete with the informal sector, who pay no taxes, when buying WLABs.
- Local fishing communities need lead weights, which are an easy product for an informal recycler to make from WLABs.
- Barriers and/or roadblocks to HSE and licensing site inspections (see below).

Section 6

6.3 Removing Barriers and Solutions for Implementing a Formalization Strategy

Table 1: Roadblocks to site inspections and possible solutions to remove them

Roadblocks to Site Inspections	Possible Solutions
1. No appreciation or understanding of the adverse health impacts of occupational or population lead exposure	Occupational health and wellbeing training
2. No understanding of the HSE issues associated with the WLAB recycling process by regulators	Training for WLAB recycling in a healthy, sustainable, and environmentally sound manner
3. Untrained to undertake an HSE inspection of a WLAB recycling plant	Training that teaches inspectors and regulators how to conduct on-site HSE assessments and audits
4. Do not know informal recyclers' locations	Formal sector recyclers should be aware of where informal recyclers operate, and on request, they should direct government inspectors to informal operations
5. License inspection not required under the law	Consider amending or introducing the licensing procedure to include a mandatory on-site HSE inspection and ESM assessment
6. Government inertia if reports for WLAB collection rates are 90%+, irrespective of the quality of the data	WLAB collection targets should be 100%

There could be many reasons why some government regulators and inspectors do not conduct on-site HSE inspections, but essentially only six main reasons have been identified by Pure Earth and the International Lead Association (ILA) when implementing WLAB recycling projects in Asia and Africa. The six reasons are listed in Table 1 above and to each one a possible solution has been assigned to remove any impediment. For example, if the informal WLAB recycling sector exists because of a lack of a government's inspection and enforcement, consider what actions could be introduced to ensure that informed on-site inspections take place that check for operating permits and licenses and that examine the HSE operational standards and management.

6.4 Removing the Final Barriers to Formalizing the Informal Sector

Inadequate infrastructure and transport links are a genuine issue in many African countries, so it is often expensive to transport WLABs long distances. The journey time can run into days, not hours, even though the final destination may ensure more efficient and effective ESM of WLABs. It is therefore understandable when collectors of WLABs, such as retailers and garages, sell the WLABs to local informal recyclers, who can offer a better price than the formal recycler located some distance away.

However, the solution might not be as simple as improving the transport links. Although an updated road network could go a long way to removing certain economic barriers, it is also necessary to consider:

- Encouraging the introduction and licensing of low-capacity WLAB recyclers. With emerging technologies, it is possible to be environmentally sound, even with a moderate or low annual WLAB throughput.
- Changing the tax regime for formal WLAB recyclers so that there are tax rebates or tax breaks that cover the additional transport costs. This would enable the formal smelter to compete on price for WLABs with the informal sector, which could encourage more ESM.
- Placing a purchase levy or tax on the sale of a new LABs such that the levy can only be reclaimed by WLAB recyclers in the formal sector. This is indeed the case in Ghana, where a substantial levy is charged on all new and replacement LAB sales. The levy enables the formal sector to compete on price, because the informal recyclers cannot recover the levy, or it can help formal recyclers cover the high transport costs. In either scenario, the informal sector is squeezed out of the market with targeted regulatory intervention. Displaced workers could be employed by formal recyclers or involved in WLAB collection or other ESM activities along the supply chain. Such employment opportunities would undoubtedly offer better working conditions.

Many governments in Africa have problems funding expenditures because taxes are not only difficult to collect, but if the population is poor and the GDP is low, revenues from taxes will be at a minimum. Therefore many governments impose high import taxes on goods and services or tax business activity, such as buying a new or replacement LAB or similarly taxing the purchase of WLABs.

However, the shortcoming of this type of tax structure is that informal sector operators are not registered for VAT, so they do not pay taxes on WLAB purchases or recycling profits. In those countries with a rampant informal WLAB recycling sector, the loss in tax revenues will run into millions of USD. Such a tax strategy proves a negative tax incentive for WLAB recycling because it adds an extra cost to the formal recycler when competing with the informal sector to buy WLABs.

Given a reasonably accurate WLAB inventory, it is entirely possible to calculate the lost tax revenues. If this information can be collated by the appropriate government agencies, it could initiate a proactive campaign to remove any WLAB purchase taxation to either eliminate informal recycling or formalize the sector to boost tax revenues. Of course, such a move will help to level the playing field between the formal and informal sectors.

According to final analysis, a government's revenue is not reduced by removing levies on WLAB purchases, because the more WLABs that are recycled through the formal sector, the higher the taxes paid on either the profits earned by the formal recyclers, or the VAT paid on finished products produced by the formal LAB manufacturers.

There are also a few countries that impose severe restrictions on the movement of company profits out of the host country. If a country wants to encourage inward investment by companies in environmentally sound WLAB recycling, governments must consider how to manage or legislate fiscal policies associated with overseas investment.

The enforcement of extended producer responsibility (EPR) on the manufacturers and importers of lead acid batteries effectively makes them responsible for the ESM of WLAB recycling. EPR also reinforces the closed-loop system and strengthens a circular economy by country or region.

The major benefits of EPR are that it places responsibility on the LAB manufacturers and importers for:

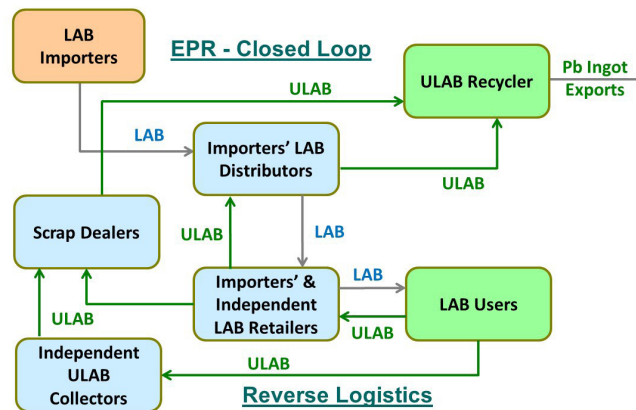


Figure 18. Closed Loop and EPR for a country without LAB manufacturing (Courtesy of the ILA).

- The ESM of WLABs, i.e., collection, storage, transport, recycling, final disposal or recycling, and aftercare of disposal and recycling sites. The manufacturers and importers must set up sales and return control mechanisms to account for all the WLABs generated. Effectively managed EPR programs may release the government agencies from spending valuable time enforcing compliance.
- EPR requires LAB manufacturers and importers to provide evidence that raw materials contained in LAB are sourced from legitimate and ESM suppliers with proven provenance. This means they would not buy lead from an informal recycler or a dealer linked to an informal smelting operation.

In the absence of EPR legislation, it is recommended that licensed, formal WLAB recyclers enter into national and global alliances with LAB manufacturers and importers, such that WLABs collected at retail outlets are exclusively delivered to partners in the alliance. In those cases where the tax regimes are unfavorable, EPR is not on the statute book. Regulation and enforcement can be weak, and alliances with LAB manufacturers are difficult. The formal sector should ensure that its operation is not only energy-efficient, but is also extracting all the recyclable materials from WLABs to make a range of by-products that can be sold, in addition to lead ingots. In this way, returns on the recycling of WLABs are improved and profits increased. In this manner, even under the worst-case scenario, it is possible to compete with the informal sector because they will only be selling unrefined lead bullion and polypropylene case material.

CASE STUDY:

Eliminating Informal WLAB Recycling and Developing an Environmentally Sound WLAB Recycling Industry in Senegal

In the spring of 2008, doctors at the Pikine National Hospital in Dakar became alarmed after 18 children under the age of 5 died in quick succession in the district of Thiaroye-sur-Mer (TSM) (Haefliger et al. 2009). The doctors suspected that the children died from acute lead poisoning due to constant exposure to lead dust in the air and in the soil in the yards of their homes.

At the time, one of the main money-making activities for the citizens of Thiaroye-sur-Mer, particularly for young mothers, was the informal recycling of used lead acid batteries. The recycling involved breaking up WLABs and separating the grid metallics from the paste to bag the metallic fraction and sell the bags to local traders for export. In many instances, these informal recycling activities were conducted in residential settings with children nearby. Medical experts suggested that unregulated WLAB recycling exposed nearly 1,000 people in the town to lead dust (Ibid).

The government of Senegal contacted the World Health Organization (WHO) and the Basel Secretariat, which in turn asked the ILA for technical assistance and Pure Earth (then known as the Blacksmith Institute) for advice regarding remediation. These four international organizations, together with medical experts from the University of Dakar's Toxicology Department, the Senegalese Ministry of Health, the Ministry of the Environment and Natural Resources, and the Basel Convention Coordinating Centre for French-speaking Africa, formed a taskforce to reduce blood lead levels and develop an environmentally sound WLAB recycling industry in Senegal.

Following advice from the forerunner of Pure Earth and the ILA, the Senegalese government quickly shut down the informal battery recycling operations and removed 300 tons of lead-contaminated soil, sand, and WLAB waste and replaced it with clean soil and sand.

Following the government's intervention and remediation of the contaminated soil and sand, the blood lead levels of the population began to fall, and no more infant deaths involving lead poisoning were reported. Pure Earth staff also taught the residents how to decontaminate their homes.

The ILA advised that in order to prevent more informal WLAB recycling operations from being established in the townships around Dakar, a domestic, environmentally sound lead smelter was needed. As a result of contacts within the lead industry, and with the support of the UN International Lead Zinc Study Group and the UN Common Fund for Commodities, the ILA secured the support of Gravita, an Indian recycling company that was interested in designing and building a WLAB recycling plant in Senegal. The investment made by Gravita enabled

the Senegalese government to comply with its obligations under the Basel Convention proximity clause. Consequently, it prohibited the export of WLABs on the basis that WLABs would be recycled in an environmentally sound manner within Senegalese territory. Gravita also agreed to pay traders a fair price for WLABs at a rate set by the government to avoid the resurgence of an informal recycling economy.

The government of Senegal and Gravita also agreed to locate the new WLAB recycling plant at Sebikotane, which is about 50 kilometers east of Dakar, on a secure site not prone to flooding during the rainy season. In 2010, the first year of operation, the plant produced about 8,000 metric tonnes of lead bullion from recycled WLABs, and in 2012, a second furnace was added when the government granted licenses to Gravita to import WLABs from neighboring countries. Output has continued to increase, and the secondary lead bullion is currently exported to 11 countries worldwide (UN n.d.). The company is now considering moving to a larger site.

Gravita also adopted a policy of recruiting and training employees from the local community, thereby creating "green jobs" for the citizens of Sebikotane. These are considered green jobs not only because WLAB recycling can be considered part of a circular economy, but also because the workers are employed at a plant that has environmental controls to mitigate possible lead contamination, are equipped with the necessary personal protective equipment, and have access to changing rooms and showers. This also built local knowledge and capacity to ensure the ESM of WLABs, guaranteeing sustainability.

Several key factors led to systemic change concerning WLAB recycling in Senegal and have ensured that the tragedy that occurred regarding the deaths of so many young residents is unlikely to happen again. For one, the government of Senegal was committed to resolve the lead exposure and contamination problems at Thiaroye-sur-Mer and prevent future issues. Second, close cooperation among national and international agencies ensured a coordinated approach to the ESM of WLABs. Lastly, securing the investment of a major WLAB recycling company in the design, construction, commissioning, and operation of an environmentally sound recycling operation was key to a long-term solution.

The extent and level of cooperation between the various government agencies in Senegal, the WHO, Pure Earth, the Basel Convention Regional Centre based in Senegal, the Basel Convention Secretariat, and the ILA, along with coordination with an established industry partner, is a model for future WLAB recycling projects in Africa and other low- and middle-income countries.

Section 7

Effective Public Communication, Awareness, and Education

Prevention of occupational and population lead exposure and the avoidance of environmental contamination from improper handling of WLABs is paramount to public health. The cost of measures to prevent lead exposure, especially among children, and avoid contamination of the environment is far more desirable than dealing with high levels of lead exposure, lead poisoning, and the remediation of lead-contaminated sites after the fact. Promoting the ESM of WLABs requires communication and education of those involved in the LAB industry, the WLAB sector, consumers, and populations at risk. These include battery retailers, WLAB collectors, transporters, and recyclers, as well as their families and neighbors. In many cases, people who sell and use LABs and those who recover WLABs lack the basic knowledge of the risks to human health and environment posed by WLABs. Education at all levels of society is therefore essential for the safe handling and sound recycling of WLABs.

There are seven elements (Figure 20) to effective communication that are key to delivering the messages that will help to mitigate the HSE risks associated with WLAB recycling.

- **Clarity:** The message should be delivered to the target audiences in their first language – without ambiguity, assumptions, limitations, or qualifications – and in a manner that it is easily understood and remembered.
- **Attention:** For effective communication, engage with the audience and maintain eye contact to command attention. Whenever possible, be interactive and positive when delivering the message, but also pose questions, make the audience think about the subject matter, and try to personalize the experience. Securing audience attention using web-based platforms presents special challenges, so try to limit the number of participants and ask each



Fig 19: Automated furnace charger and furnace (Courtesy of Green Recycling Industries Ltd., Agbara, Nigeria, and STC, Italy).

Section 7

one to keep their video on at all times if connecting remotely. When delivering the message, look directly into the camera so that you appear to be looking into the eyes of the receivers.

- **Feedback:** Feedback is the mechanism that determines whether the message has not only been delivered but also understood. It is important to obtain feedback from your audience. This can be through a series of questions for the delegates in a live, face-to-face setting, or through a questionnaire for remote communications.
- **Formality and Informality:** Depending on the target audience, there will be occasions when a formal approach to communication is appropriate, such as when addressing government representatives or senior business executives. However, formal communication may not achieve the desired results in a workplace or community setting. In these instances, an informal approach to delivering the message may prove more effective. What is important is to choose the right approach for each situation.
- **Consistency:** Situations and circumstances will vary from region to region and country to country, so it is imperative that communication should always be consistent with the prevailing policies, plans, and programs, and that objectives of the country or participating organization are not in conflict. Messages and communications that are in conflict with existing policies and projects will leave the target audience confused, and the message may be lost or misunderstood.
- **Timeliness:** Once a communication and education program has been planned, it should be delivered as soon as possible while the content is relevant.
- **Adequacy:** The content of the information communicated should be as complete as possible in every respect. Educational material that is incomplete or lacking in detail will leave some audience members guessing as to what is meant and what action is required, and may also delay decision-making and the preparation of action plans. Consolidate any verbal or internet-based communication with easy-to-understand handouts or files to download.

It should also be borne in mind that peoples' behaviors and actions in life vary in the context of their gender norms and roles, which can in turn affect how they engage with any proposed activities designed change attitudes, behaviors or increase understanding. This includes differences in the level of participation, accepting or seeking information, attending meetings and training courses, changes in purchase and disposal behaviors and possibly development



Figure 20: The Seven Effective Communication Principles
(Courtesy of the ILA).

activities. Communication and outreach activities should therefore include such considerations (Peña-López, et al. 2020).

Information about the need for WLABs to be recycled in an environmentally sound manner is likely to be most effective when the information is delivered at the point of sale for a replacement LAB, which is at the retail outlet. Personal interaction between the salesperson and the consumer where individual citizens can ask questions will undoubtedly be more effective than posters and internet-based social media, although all communication avenues should be considered and used. In this context, LAB manufacturers should supply more information about the benefits of sustainable WLAB recycling either as a label on a new LAB or accompanying literature.

Additionally, opportunities to get the message about lead exposure to populations at special events can mean that the message will have impact because it may only be heard or seen once or twice a year. Special events such as World Environment Day or World Health Day will put more pertinent information in front of local populations and community groups. Any education effort will be more effective if it is linked to a broader campaign such as the WHO's International Lead Poisoning Prevention Week (ILPPW), which aims to raise awareness about the health effects of lead exposure and to highlight the efforts to prevent lead exposure, particularly in children (WHO, n.d.).

CASE STUDY:

Against All Odds: How Phyllis Omido Changed WLAB Recycling in Kenya through Effective Communication and Compelling Information

Phyllis Omido had never intended to become an environmentalist, but she was prompted to action when infant lead poisoning became a personal matter after the birth of her son. After earning a Business Administration degree from the University of Nairobi, Ms. Omido was recruited by Metal Refinery Limited (MRL) in 2009 to become the company's Community Relations Manager. MRL was a company licensed by Mombasa's Export Processing Zone Authority (EPZ) to operate a used lead acid battery recycling plant located close to the Owino Uhuru community on the outskirts of Mombasa.

The MRL lead recycling plant, which began operations in 2008, produced pure lead ingots for export. Not long after operations commenced, some of the local population of Owino Uhuru began to complain about dust and fallout from the plant. Following a hearing by the Kenyan Public Complaints Committee (2009), the company commissioned Ms. Omido to conduct an environmental impact assessment (EIA) of the recycling operation. The EIA report compiled by Ms. Omido concluded that the manner of operations at the Metal Refinery plant was having an adverse health impact on the 3,000 residents of Owino Uhuru. The report recommended to the management that the plant should be relocated away from residential areas.

Coincidentally, at about the same time that Ms. Omido was conducting the EIA at the recycling plant, her infant son started to develop a daily fever and began vomiting frequently. Ms. Omido took her son to the local hospital, where he tested negative for malaria, typhoid, and rotavirus.

It is not unusual for such tests to be conducted given the baby's symptoms, because the symptoms of acute lead

poisoning and certain tropical diseases are similar, and the medical teams would not have suspected lead poisoning cases to be present in Mombasa. However, a colleague of Ms. Omido's suggested that her son be tested for lead intoxication. In the testing, Ms. Omido's son's blood lead level was found to be 35 micrograms per deciliter, which is seven times the "reference level" used by the U.S. Centers for Disease Control and Prevention (5 micrograms per deciliter) that triggers case management in the U.S. Puzzled as to how her son developed an elevated blood lead level (BLL), Ms. Omido was advised by her doctor that ingestion through breast milk was the most likely pathway.

However, when Ms. Omido raised the issue of her son's health with the company, she reported that the management was indifferent to her concerns. Ms. Omido realized her continued employment was untenable, and she resigned after only three months of employment.

Shortly after leaving MRL, Ms. Omido founded the Centre for Justice, Governance, and Environmental Action (CJGEA) and began a peaceful community-based campaign on behalf of the residents of Owino Uhuru to alert Kenya's Public Health Agency (PHA) and the National Environmental Management Agency (NEMA) to the extent of lead pollution and environmental contamination caused by improper WLAB recycling practices at MRL (Human Rights Watch 2014). The PHA eventually conducted a 2010 survey, which found that many residents of Owino Uhuru had elevated BLLs despite never working at the plant. In spite of these findings, MRL continued to operate, albeit with a number of temporary shutdowns ordered by the NEMA (Kiaka 2010).

The media publicity campaign and the public protests organized by the CJGEA against the operations of MRL continued, and in 2012, the first independent, in-depth scientific study to ascertain the level and extent of population lead exposure and environmental contamination at Owino Uhuru was carried out (Okeyo and Wangila 2012). The survey confirmed the results of the PHA survey of 2010, strengthening Ms. Omido's assertion that the plant was responsible for the elevated BLLs among Owino Uhuru's population due to environmental contamination from the disposal of untreated toxic waste from the recycling process.

In 2013, Ms. Omido's campaign attracted the attention of Human Rights Watch and the United Nations Special Rapporteur on toxic waste. With international support, the issue of lead poisoning in Owino Uhuru was presented in 2014 to the Kenyan Senate, whose representatives visited the plant to conduct their own inspection in person. The Senate's report was passed to the Environment Committee to consider the case and take appropriate action. Subsequently, the NEMA was ordered to permanently close the MRL operation in Owino Uhuru, along with other polluting WLAB recyclers in Mombasa.

In 2015, Ms. Omido was awarded the Goldman prize for her campaign against MRL, garnering one of the world's top environmental honors. In July 2020, Ms. Omido and the CJGEA won from the Mombasa courts an award of USD \$12M (1.3 billion Kenyan shillings), collecting damages from the Kenyan government and MRL for the residents of Owino Uhuru.

Factors that led to Change

In this initiative, effective communications and advocacy were backed up with:

- Strong evidence of human health impacts (blood lead levels).
- Strong evidence of environmental contamination (soil lead levels).
- Evidence of a connection between contamination and a specific industrial operation.
- Laws guaranteeing rights to a clean and healthy environment.
- Government agencies and a judicial system that have the necessary authorities and will to enforce relevant laws once the evidence is presented and corroborated.

Section 8

Strategies for the Identification, Investigation, and Remediation of Legacy WLAB Recycling Sites

The environmentally unsound manufacturing and recycling of lead acid batteries is a common source of lead contamination in lower- to middle-income countries (LMICs) (Pure Earth n.d.). The ingestion of lead-contaminated soil and dust is the most prevalent non-occupational human exposure pathway, and studies have shown that lead in topsoil can be a key driver of exposures (WHO 2010; Mielke et al. 2019). Children living, playing, commuting, or learning near substandard WLAB recycling operations have been shown to have consistently elevated blood lead levels as a result of contaminated soil and dust (Danielle et al. 2015; Haefliger et al. 2009; Ericson et al. 2016; Chowdhury et al. 2021).

Unlike some other toxic soil contaminants, lead does not degrade and can remain in soil for hundreds of years unless remediated (Semlali et al. 2004; Taylor et al. 2010). Lead-contaminated superficial soil can thus continue to expose local residents for generations. Because of these factors, investigating and remediating or mitigating risks at lead-contaminated WLAB recycling sites is an essential element – in conjunction with promoting the ESM of WLABs (Sections 4 and 5) – in addressing the toxic legacy and to reducing lead exposures, along with the associated health and economic impacts.

Ideally, if all secondary lead plants operated in an environmentally sound manner every day or shift, then any spillage or contaminating emission would be contained and eliminated, thereby minimizing the risk of leaving a contaminated site should the recycling operation have to close for any reason. However, such mitigation measures to prevent contamination are not always followed, and legacy sites are often contaminated. Fortunately, the successful remediation of lead-contaminated soil has been demonstrated in a variety of LMICs using local equipment, materials, and labour, and has proven successful at reducing population lead exposures. Many of these demonstration remediation projects include relatively low-tech but cost-effective strategies to reduce occupational and population lead exposures and protect human health and the environment (Laidlaw 2017).

8.1 Sources of Lead and Exposure Pathways from WLAB Sites

The substandard handling and management of WLABs results in lead being released into the environment, causing adverse human health and environmental impacts, with the sources and impacts being variable and site-specific along the WLAB supply chain. The sources of lead releases into the environment, their distribution in the environment, and the potential sources of lead exposure to humans must be evaluated on a site-specific basis.

Potential sources of lead being released into the environment include:

- Release of lead-contaminated acid and dust during battery breaking and/or poor handling during improper storage and transportation of WLABs.
- Lead released during smelting activities with no or substandard emissions controls, causing relatively widespread atmospheric deposition of lead oxides impacting surficial soil, foodstuffs, etc.
- Improper management or containment of lead-contaminated slag generated during smelting.
- Lead released during battery reconditioning or informal battery manufacturing operations.
- Improper management of WLAB-related lead-contaminated wastes (e.g., separators, cases, discarded lead batteries, and other castoff materials).
- Lead dispersed through “take-home” exposure from workers involved in various active WLAB operations, children playing at or near legacy sites, and re-use of lead contaminated battery cases (e.g., for planters, to carry water, or as stools).

Section 8

Lead in the environment does not degrade over time. Primary exposure pathways include:

- Inhalation and ingestion of lead dust from contaminated soils in the area surrounding substandard active or legacy smelting operations.
- Contact with WLAB-related lead-contaminated wastes (e.g., lead slag from smelting activities, separators, discarded lead battery paste, cases, and other discarded materials).
- Ingestion of lead-impacted foodstuffs contaminated through uptake of lead from soil or lead-contaminated dust on the foodstuffs themselves (e.g., leafy vegetables).
- Ingestion of animals impacted from WLAB operations (e.g., cows and chickens in the area of WLAB recycling operations).
- Ingestion of lead-contaminated water impacted from WLAB operations (e.g., through shallow well water). While water is generally not a significant exposure pathway due to the relatively low solubility of lead oxides and sulfates released during WLAB recycling operations, this should be confirmed through environmental sampling.
- Exposure to lead-contaminated dust on floors, walls, furniture, mattresses, and other items.

8.2 Core Principles of Lead-contaminated Site Remediation and Risk Mitigation

In this context, risk mitigation generally refers to managing exposure risks through physical barriers such as fencing, capping with clean soil, burial of contaminated soil, etc., along with appropriate institutional controls (e.g., land-use restrictions) and a monitoring and maintenance plan to ensure that such risk reduction measures remain effective over time. Such risk mitigation techniques are generally viewed as temporary or semi-permanent depending on the controls that are emplaced. Remediation in this context generally refers to a more permanent solution such as excavation and off-site management of contaminated soil at a permitted facility. Often, remediation options in LMICs are limited and significantly more expensive, while risk mitigation options are more cost-effective and feasible using local resources and can achieve meaningful reductions in exposure in the short-term.

The following core principles should be considered with respect to risk mitigation and site remediation, although this is not an exhaustive review and site-specific evaluations of options is warranted:

- Survey the contaminated site to determine the extent and characteristics of the pollutants and prepare a detailed remediation/mitigation implementation plan (EPA n.d. b; Burton et al. 1995; EPA 2010).
- Soil remediation and risk mitigation is most appropriate for sites where the source is no longer actively releasing lead into the environment (for example, the source has moved, closed, or instituted effective environmental controls).
- To the extent possible, the “polluter pays” principle should be observed.
- Remediation and risk mitigation strategies should be tailored to the specific conditions of the site and local community (there is no “one size fits all” solution) and should be based on a comprehensive assessment of the distribution of lead in the environment and the exposure sources (Triad n.d.).
- To the extent possible, remediation and risk mitigation strategies should use local materials, equipment, labour, and managers to increase local capacity, local awareness, and replicability within the region.
- Remediation and risk mitigation projects should be organized in collaboration with local authorities, and with the full knowledge and approval of community members (Mintz, Aldrete and Mitchell 2003).
- Where populations live in or near the remediation project area, every effort should be made to consult and involve them in the preparation of the project plan.
- Remediation and risk mitigation projects should be coupled with education programs for local community members to gather their input and inform them of the risks of lead exposure, teach strategies to reduce personal exposure, communicate any anticipated disruptions to their daily lives, honor the confidentiality and intended use of any biomonitoring data, and address any questions or concerns.
- If possible, remediation and risk mitigation projects should include blood lead level (BLL) monitoring of local children before and after the project to establish the need for intervention as well as baseline (pre-project) BLLs, and to evaluate the impact of the project on children’s lead exposures once the project has been completed. Biomonitoring of human subjects requires informed consent, may require the approval of an institutional review board, and should be coordinated with appropriate health agencies.

- Remediation and risk mitigation options, strategies, and implementation plans should be developed in consultation with experts to ensure the application of best practices, and in consideration of applicable laws and regulations (New Jersey Department of Environmental Protection (NJDEP) n.d.).
- The long-term site maintenance should be considered when selecting remediation and risk mitigation strategies to avoid recontamination or other unintended consequences.

8.3 Steps to Implement National Remediation Programs, Site Remediation and Risk Mitigation Projects

A recommended goal of a national lead remediation program is to mitigate exposures at sites that pose the greatest risks. This could be defined as sites that pose exposure risks to the greatest number of people, sites that cause the most severe exposures, or some combination of these factors.

To ensure that all (or most) potentially hazardous sites are considered in the subsequent assessment and prioritization processes, stakeholders should begin by identifying a long list of known or potentially contaminated sites associated with WLABs. The purpose of this exercise is to identify potential sites for field investigations and to gather initial information about each potential study, which may include gathering information about the nature and timing of polluting operations, the current use of the site and surrounding areas, demographic and behavioral information on area residents, the environmental setting, and other information that may help characterize risks. This information is intended to help evaluate the need for additional investigative work, e.g., further investigation of a former WLAB recycling site that is now an elementary school may be prioritized over a similar site that is in an industrial area.

The steps outlined below can help in designing and implementing a national lead remediation program for sites contaminated with lead from substandard WLAB handling. These suggested steps are not the only potential strategy, but they have been used effectively in LMICs to evaluate and reduce human exposures and protect public health, while utilizing limited resources and limited remedial alternatives.

1. Identification of known or potentially contaminated sites to ensure that all (or most) hazardous sites are considered in the assessment and prioritization processes.
2. Initial on-site screening of known or potentially contaminated sites to provide a basic characterization of the site and potential risks, often completed with the use of a portable field instrument such as an XRF to measure soil lead concentrations and a GPS unit to record latitude and longitude to enable mapping.
3. Prioritization or shortlisting of sites for further assessment based on initial site screenings, mapping of lead concentrations, and assessment of potential risks.
4. Preliminary assessments of priority sites to gain an understanding of the degree and extent of the lead impacts and the potential risks posed to the surrounding population.
5. Risk evaluation and prioritization of sites for potential risk mitigation or remediation.
6. Detailed assessments of shortlisted sites to evaluate the 3-D distribution of lead in the environment, assessment of exposure pathways, and factors impacting selection of potential remedial and/or other risk mitigation alternatives.
7. Selection of sites for remediation or risk mitigation based on detailed site assessments.
8. Evaluation and selection of various short-term and long-term risk mitigation and remediation activities with community input, including such alternatives as excavation and off-site handling; scraping and burial of contaminated soil in an on-site containment structure; paving of contaminated areas; limiting access to contaminated areas; providing potable water; in situ or ex situ phytoremediation; application of soil amendments (e.g., phosphate) to reduce bioavailability/leachability; house cleaning; or a combination thereof.
9. Coordination and confirmation of project logistics (e.g., approvals, funds, contractors)
10. Community input, awareness, and education campaign.
11. Blood lead level testing to evaluate the human impacts of lead contamination and effectiveness of the selected remediation and risk reduction project activities.
12. Implementation of risk reduction and remediation actions.
13. Post-intervention monitoring, evaluation, and impact assessment.
14. Long-term site care and management, as warranted.

CASE STUDY:

Lead Poisoning and Intervention in Thiaroye-sur-Mer, Dakar, Senegal

Prior to 2008, the main economic activity in Thiaroye-sur-Mer (TSM), in Dakar, Senegal, was fishing. However, when fish stocks were depleted by foreign factory ships, fishing declined dramatically, leading to economic strife. Hardship and hunger led families to resort to the informal recycling of used lead acid car batteries, which involved the haphazard breaking and smelting of car batteries to reclaim the scrap lead. Often done in open-air communal settings or residents' yards, the unregulated recycling exposed the environment and some 40,000 people to lead dust. In 2008, an episode of 18 child deaths in this community revealed the fatal dangers of informal battery recycling to the residents of TSM and the surrounding community.

After the childhood deaths in TSM, the government worked quickly to shut down these battery smelting operations. However, the legacy of many years of unregulated lead processing had rendered the entire community exceedingly polluted. In April 2008, the Ministry of Health, in conjunction with the University of Dakar Toxicology division, conducted blood tests among 41 children of TSM, revealing severe impacts: 100% of the children tested had blood lead levels over 10 µg/dL, with the highest average being 158 µg/dL for the 1-to-5-year age group. Contaminated soils tested at over 400,000 ppm, far exceeding the EPA standard of 400 ppm for residential soil. A risk mitigation and remediation project was certainly warranted and brought together Pure Earth (then Blacksmith Institute), TerraGraphics Environmental Engineering, Inc., the World Health Organization, the International Lead Management Center (ILMC – now a program within the ILA), the Senegalese government, the University of Dakar's Toxicology department, the Senegalese Ministry of Health, and others to address the dire situation. Pure Earth and others helped to characterize the source of the problem and to design and implement a practical solution aimed at remediating the soil contamination and reducing risks of lead exposure.

The solution adopted included removal and subsequent burial of highly contaminated materials from the working areas and cleaning of both public areas and private houses (where material had been stored). Technical advisors trained government workers and local contractors on how to adequately and safely remove the contamination.

The lead-contaminated soil was dug up with a backhoe by locals working in appropriate personal protective gear. With rakes and shovels, they filled up canvas bags with the soil and placed them in a dump truck, and the truck transported the contaminated soil to the municipal dump for burial in a containment structure. The project also involved cleaning more than 100 homes with high-powered vacuum cleaners and scrubbing them with heavy detergents to remove the lead dust. The University of Dakar's Toxicology department and the Senegalese Ministry of Health engaged local village and religious leaders in educating the populace about the dangers of lead toxicity and the persistence of its health effects through WLAB recycling.

The work in TSM was a success. Informal processing and recycling of used batteries was shut down. Lead concentrations in the soil at TSM were reduced to levels below 400 ppm by excavation and off-site burial, and blood lead levels in children were significantly reduced as a result of the risk mitigation and remediation project. This remarkable turnaround was achieved not only through education and the clean-up, but by also providing alternative livelihoods to people involved in WLAB recycling, including training women in hydroponic agriculture.

References

- Adie, G. U. and Osibanjo, O (2009). Assessment of soil-pollution by slag from an automobile battery manufacturing plant in Nigeria. *African Journal of Environmental Science and Technology* 3(9):239 – 250.
- Atiemo, S., Faabeluon, L., Manhart, A., Nyaaba, L., Schleicher, T. (2016). *Baseline Assessment on E-waste Management in Ghana. Accra: Sustainable Recycling Industries.* www.sustainable-recycling.org/ghana-makes-big-steps-towards-sound-recycling-of-used-lead-acid-batteries/. Accessed 11 October 2022.
- Chowdhury, KIA., Nurunnahar S., Kabir ML., Islam MT., Baker M., Islam MS., Rahman M., Hasan MA., Sikder A., Kwong LH., Binkhorst GK., Nash E., Keith J., McCartor A., Luby SP, & Forsyth, J. (2021). Child lead exposure near abandoned lead acid battery recycling sites in a residential community in Bangladesh: Risk factors and the impact of soil remediation on blood lead levels. *Environmental Research* 194:110689. doi: 10.1016/j.envres.2020.110689.
- Daniell, W. E., Van Tung, L., Wallace, R. M., Havens, D. J., Karr, C. J., Bich Diep, N., Croteau G., Beaudet N., & Duy Bao, N. (2015). Childhood lead exposure from battery recycling in Vietnam. *BioMed Research International*. DOI: [https:// doi.org/10.1155/2015/193715](https://doi.org/10.1155/2015/193715).
- EPA (2010). *Best Management Practices: Use of Systematic Project Planning under a Triad Approach for Site Assessment and Cleanup.* EPA 542-F-10-010. <https://clu-in.org/download/char/epa-542-f-10-010.pdf>. Accessed 12 October 2022.
- EPA (n.d. a). Lead Regulations. www.epa.gov/lead/lead-regulations. Accessed 11 October 2022.
- EPA (n.d. b). Superfund Site Assessment Process. www.epa.gov/superfund/superfund-site-assessment-process. Accessed 12 October 2022.
- Burton, J., Walker, J. Aggarwal, P. & Meyer, W. (1995). Argonne`s Expedited Site Characterization: An integrated approach to cost-and time-effective remedial investigation.
- Ericson, B., Landrigan, P., Taylor, M. P., Frostad, J., Caravanos, J., Keith, J., & Fuller, R. (2016). The Global Burden of Lead Toxicity Attributable to Informal Used Lead Acid Battery (ULAB) Sites. *Annals of Global Health* 82(5), 686–699, 2016). DOI: [https:// doi.org/10.1016/J.AOGH.2016.10.009](https://doi.org/10.1016/J.AOGH.2016.10.009).
- García, D., and Marín, J. (2016). Dirty business: Africa's unregulated lead battery smelting. *The Ecologist*. www.theecologist.org/2016/mar/03/dirty-business-africas-unregulated-lead-battery-smelting.
- Gottesfeld, P, Were, F. H., Adogame, L., Gharbi, S., San, D., Nota, M. M. and Kuepouo, G. (2018) Soil contamination from lead battery manufacturing and recycling in seven African countries. *Environmental Research* 161: 609–614
- Haefliger, P., Mathieu-Nolf, M., Locicero, S., Ndiaye, C., et al. (2009). Mass Lead Intoxication from Informal Used Lead-Acid Battery Recycling in Dakar, Senegal. *Environmental Health Perspectives* v. 117, No. 10. <https://doi.org/10.1289/ehp.0900696>.
- Health and Safety Executive (HSE) (2019). Guidance on respiratory protective equipment (RPE) fit testing. www.hse.gov.uk/pubns/indg479.pdf. Accessed 11 October 2022.
- Human Rights Watch (2014). Kenya: Factory Poisons Community. [online video]. June 24. <https://www.youtube.com/watch?v=Ak-DiczT29M>. Accessed 11 October 2022.
- ILA (n.d.) Sustainability. www.ila-lead.org/sustainability/. Accessed 10 October 2022.
- ILO (2016). More than 60 percent of the world's economy employed population are in the informal economy, 30 April. www.ilo.org/global/about-the-ilo/newsroom/news/WCMS_627189/lang-en/index.htm
- International Lead and Zinc Study Group (ILZSG) (n.d.). ILZSG Interactive Mine and Smelter Database. <https://minesmelter-database.ilzsg.org>.

Accessed 11 October 2022.

Kiaka (2010). Public Health Department on blood lead levels of residents in Owino Uhuru slums.

Manhart, A., Amera, T., and Kuepouo, G. (2016). *The Deadly Business – Findings from the Lead Recycling Africa Project*. Freiburg, Germany: Oeko-Institut e.V. www.oeko.de/oekodoc/2549/2016-076-de.pdf.

Mielke, H. W., Gonzales, C. R., Powell, E. T., Laidlaw, M. A., Berry, K. J., Mielke, P. W., & Egendorf, S. P. (2019). The concurrent decline of soil lead and children's blood lead in New Orleans. *Proceedings of the National Academy of Sciences* 116(44), 22058-22064.

Mintz, S., Aldrete, R., and Mitchell, C. (2003). *Project Management Toolkit of the US Agency for International Development*. https://pdf.usaid.gov/pdf_docs/Pnacy789.pdf. Accessed 12 October 2022

New Jersey Department of Environmental Protection (NJDEP) (n.d.) Site Remediation & Waste Management Program. www.nj.gov/dep/srp. Accessed 12 October 2022.

Okeyo, B. and Wangila, A. (2012). *Lead Poisoning in Owino Uhuru Slums in Mombasa – Kenya*. Eco-Ethics International.

Onianwa, P. C. and Fakayode, S. O. (2000) Lead Contamination of Topsoil and Vegetation in the Vicinity of a Battery Factory in Nigeria. *Environmental Geochemistry and Health* 22 (3):211 – 218.

Peña-López, I., Martín, L., García, M., Pacheco, J., Goula, B. (2020). Guide to gender mainstreaming in participatory processes. www.oidp.net/docs/repo/doc954.pdf. Accessed 11 October 2022.

Pure Earth (n.d.). Toxic Sites Identification Program. <http://contaminatedsites.org>. Accessed 26 January 2021.

Pure Earth and Green Cross Switzerland (2016). *World's Worst Pollution Problems 2016: The Toxics Beneath Our Feet*. <http://worstpolluted.org/docs/WorldsWorst2016Spreads.pdf>. Accessed 31 May 2021.

Pure Earth and UNICEF (2020). *The Toxic Truth: Children's exposure to lead pollution undermines a generation of future potential*. www.unicef.org/reports/toxic-truth-childrens-exposure-to-lead-pollution-2020.

Semlali, RM., Dessogne, J.B., Monna, F., Bolte, J., Azimi, S., Navarro, N., Denaix, L., Loubet, M., Chateau, C., and van Oort, F. Modeling lead input and output in soils using lead isotopic geochemistry. *Environmental Science & Technology* 38 no. 5: 1513-1521.

Shepard, S. (2021). PPE for Women: Why Fit Matters, March 10. <https://ohsonline.com/articles/2021/03/10/ppe-for-women-why-fit-matters.aspx>. Accessed 10 October 2022.

Sianipar, C. P. M., Dowaki, K., Yudoko, G., & Adhiutama, A. (2013). Seven Pillars of Survivability: Appropriate Technology with a Human Face. *European Journal of Sustainable Development* 2(4), 1. <https://doi.org/10.14207/ejsd.2013.v2n4p1>.

Sustainable Recycling Industries (SRI) (2017). Ghana makes big steps towards recycling of used lead-acid batteries, 25 August. www.sustainable-recycling.org/ghana-makes-big-steps-towards-sound-recycling-of-used-lead-acid-batteries/. Accessed 11 October 2022.

Taylor, M. P., Mackay, A. K., Hudson-Edwards, K. A., & Holz, E. (2010). Soil Cd, Cu, Pb and Zn contaminants around Mount Isa city, Queensland, Australia: Potential sources and risks to human health. *Applied Geochemistry* 25(6), 841-855, 2010. <https://doi.org/10.1016/j.apgeochem.2010.03.003>.

The Kenyan Public Complaints Committee (2009). *Report of the Parliament Standing Committee on Human Health: Annex: Public Complaints Committee Report*. (n 12) 23–28.

Triad (n.d.). Triad Overview. <https://triadcentral.clu-in.org/over/index.cfm>. Accessed 12 October 2022.

U.S. Department of Labor (n.d.). Lead: Secondary Lead Smelter. www.osha.gov/SLTC/etools/leadsmelter/popups/batterysaw_popup.html. Accessed 11 October 2022.

UN (n.d.). UN Comtrade Database. <https://comtradeplus.un.org>. Accessed 11 October 2022.

UNEP (1992). Basel Convention on the Control of Transboundary Movements of Hazardous Wastes and their disposal. www.basel.int/TheConvention/Overview/TextoftheConvention/tabid/1275/Default.aspx. Accessed 10 October 2022.

UNEP (2003). Technical guidelines for the environmentally sound management of waste lead-acid batteries. Geneva. <http://archive.basel.int/pub/techguid/tech-wasteacid.pdf>. Accessed 10 October 2022.

